

The V7P loudspeaker



V7P loudspeaker

The 3-way passive V7P loudspeaker features two 10" drivers in a dipole arrangement with a horn loaded 8" MF driver and a 1.4" exit compression driver mounted onto a rotatable CD horn. The innovative horn design for the centrally mounted 8" MF driver produces a remarkable sensitivity resulting in an exceptional performance in the vocal range. An advanced bass-reflex and venting design delivers an extended LF output with full bandwidth capabilities. All components are arranged symmetrically around the centre axis of the cabinet to produce a perfect symmetrical dispersion pattern. Due to the dipolar arrangement of the LF drivers, broadband dispersion control is maintained down to approximately 350 Hz in the same plane as the dipole.

The high performance V7P provides a broad variety of deployment possibilities, especially when used as a stand-alone full range system, or combined with other elements from the V-Series, either ground stacked or flown. The HF horn can be rotated by 90° to enable horizontal orientation.

The loudspeaker cabinet is constructed from marine plywood, and has an impact and weather protected PCP (Polyurea Cabinet Protection) finish. The front of the loudspeaker cabinet is protected by a rigid metal grill. The cabinet incorporates a pair of handles whilst M10 threaded inserts are provided for attaching d&b rigging hardware. Additionally, three further M10 sockets accept an 8 mm load pin to expand the mounting options.

d&b amplifiers

The d&b audiotechnik loudspeaker range is designed exclusively for operation with d&b amplifiers. These provide power as well as comprehensive control and protection functions tailored to achieve the performance, reliability and longevity associated with the d&b System approach.

The d&b D80 amplifier is recommended to drive the V7P. The d&b D20 and 30D amplifiers can also be used with the appropriate loudspeaker configuration selected.

System data

Frequency response (-5 dB standard)	59 Hz - 18 kHz
Frequency response (-5 dB CUT mode)	100 Hz - 18 kHz
Max. sound pressure (1 m, free field) ¹	
with 30D/D20	137 dB
with D80	140 dB

Loudspeaker data

Nominal impedance	8 ohms
Power handling capacity (RMS/peak 10 ms)	500/2000 W
Nominal dispersion angle (h x v)	75° x 40°
Components	2 x 10" driver with neodymium magnet
.....	1 x 8" driver with neodymium magnet
.....	1 x 1.4" exit compression driver
.....	passive crossover network
Connections	2 x NLT4 F/M
.....	optional 2 x NL4 or 2 x EP5
Weight	33 kg (75 lb)

¹ Broadband measurement, pink noise, crest factor 4, peak measurement, linear weighting

The V7P loudspeaker

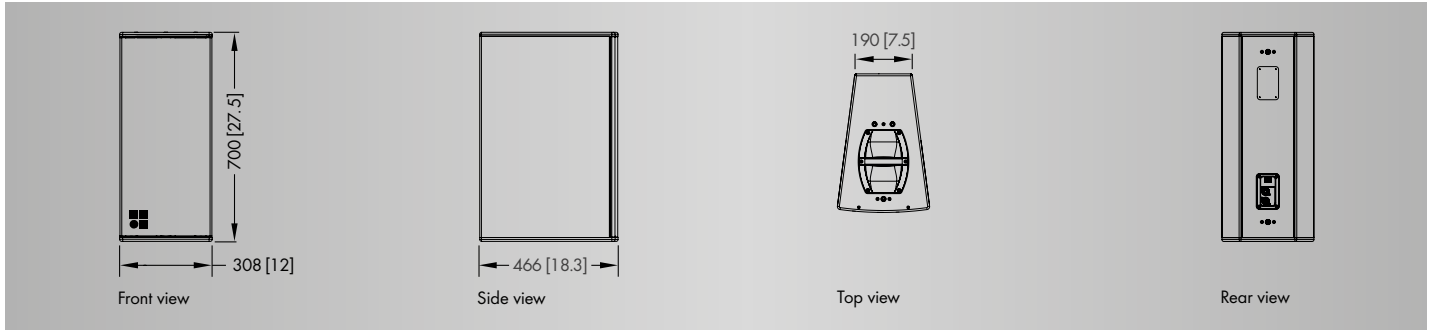

V7P cabinet dimensions in mm [inch]

Features and benefits

- High performance point source loudspeaker
- Compact and powerful performance in a single box
- 3-way passive design with 2 x 10" LF drivers, 1 x horn loaded 8" MF driver and 1 x 1.4" exit HF driver on a rotatable CD horn
- Extended LF performance from large cabinet volume and port design
- Extended MF performance from high sensitivity mid range horn
- Vi7P installation specific cabinet option
- Outstanding performance/size ratio (SPL) for applications, where smaller line arrays are not first choice
- Impressive throw and even tonality at longer distances
- Highest SPL at lowest distortion

Applications

- Mobile music and live program reinforcement
- Theatrical sound reinforcement
- Concert halls
- Live performance venues
- Night clubs
- Houses of Worship

Architectural specifications

The 3-way dipolar, passive loudspeaker shall consist of two 10" low frequency drivers, an integrated mid-range unit comprising one 8" midrange driver, all with a neodymium magnet assembly and one, coaxially mounted 1.4" exit neodymium compression driver coupled to a rotatable CD horn and a passive crossover network.

The loudspeaker shall only be operated by a dedicated, compatible controller amplifier.

The cabinet enclosure shall be made from marine plywood with an impact and weather protected PCP (Polyurea Cabinet Protection) finish. The drivers shall be protected by a rigid metal grill backed by an acoustically transparent foam.

The cabinet shall incorporate one handle on the top and bottom panel. The cabinet shall incorporate two M10 threaded inserts on the top and bottom panel for the secure attachment of dedicated mounting brackets. Three additional combined sockets, one in the top panel and two at the centre rear of the cabinet shall be incorporated to support a single cabinet or to secure the aiming of an array in conjunction with a dedicated flying pin or to apply a secondary safety device in conjunction with a safety eye bolt M10.

The connection panel on the back shall be recessed and fitted with speakon NLT4 F/M sockets (NL4 M or EP5 connectors as an option).

The HF horn shall have a nominal dispersion of 75° x 40° (h x v).

The power handling capacity shall be 500 W RMS and 2000 W peak (10 ms). The frequency response (-5 dB) measured on axis shall be 59 Hz to 18 kHz with a maximum sound pressure of at least 140 dB.

The dimensions (W x H x D) shall not exceed 308 x 700 x 466 mm (12" x 27.5" x 18.3") and shall weigh no more than 33 kg (75 lb).

The loudspeaker shall be the V7P by d&b audiotechnik GmbH & Co. KG.