



LVP605 series LED HD Video Processor

User Manual



SHENZHEN VDWALL CO., LTD.

Content

Chapter 1	Safety precautions	03
Chapter 2	Item list	04
Chapter 3	Hardware connection	05
	3-1 Rear view.....	05
	3-2 Port description.....	05
	3-3 Connection diagram.....	07
Chapter 4	Front panel	08
	4-1 Front view.....	08
	4-2 Instructions.....	10
Chapter 5	Settings	14
	5-1 Basic settings.....	15
	1. Enter settings menu.....	15
	2. Select language.....	16
	3. Output image settings.....	17
	4. Text overlay.....	19
	5. Brightness / saturation / sharpness.....	20
	6. Audio configuration.....	20
	7. Hot spare.....	21
	8. Test pattern.....	21
	9. Factory settings.....	21
	5-2 PIP / PBP settings.....	24
	5-3 Mosaic settings.....	26
Chapter 6	Specifications	31
Chapter 7	Control software	34
Chapter 8	Notes about models	49
Chapter 9	Copyright information	50

Chapter 1 Safety precautions



Danger

There is high voltage in the processor, to prevent any unexpected hazard, unless you are a maintenance personnel, please do not open the cover of the device.



Warning

1. This device shall not encounter water sprinkle or splash, please do not place anything containing water on this device.
2. To prevent fire, keep this device far from any fire source.
3. If this device gives out any strange noise, smoke or smell, please immediately unplug the power cord from receptacle, and contact local dealer.
4. **Signal cables are not hot swappable.**



Caution











1. Please thoroughly read this manual before using this device, and keep it safe.
2. In the event of lighting or when you are not going to use the device for a long time, please pull the power plug out of receptacle.
3. Nobody other than professional technicians can operate the device, unless they have been appropriately trained or under guidance of technicians.
4. To prevent equipment damage or electric shock, please don't fill in anything in the vent of the device.
5. Do not place the device near any water source or anywhere damp.
6. Do not place the device near any radiator or anywhere under high temperature.
7. To prevent rupture or damage of power cords, please handle and keep them properly.
8. Please immediately unplug power cord and have the device repaired, when
 - 1) Liquid splashes to the device.
 - 2) The device is dropped down or cabinet is damaged.
 - 3) Obvious malpractice is found or performance degrades.

Chapter 2 Item list

Please unpack the product with care and check whether all the following items are included in the package. If anything is found missing, please contact the dealer.

Standard accessories

The accessories supplied with this LED Video Processor may differ from the figures contained in the User Manual, but they are applicable for the regions where you live.

		
Power cord(1.5m)	DVI cable(1.5m)	DVI cable(0.5m)
		
RS232-RJ45(1.5m)	Net cable (0.2m)	BNC-RCA adapter X 3
		
DVI-I to VGA adapter (only for LVP605D)	PCB connector (Audio)	User manual
		
Disk		

Chapter 3 Hardware connection

3-1 Rear view

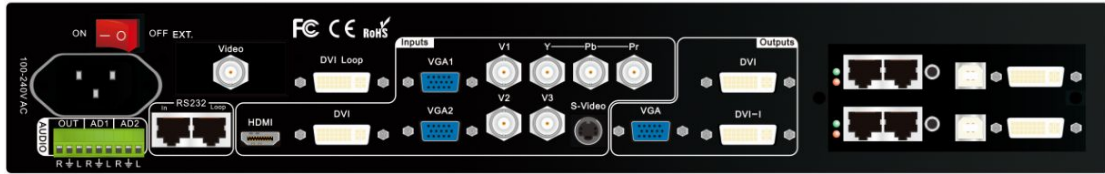

Figure 3-1 Rear view

3-2 Port description

1) Video input signals (**INPUT**)

LVP605 supports 10 video input signals as follows:

Port	Description
V1~V3	3 X Composite Video (PAL /NTSC)
S-Video	1 X S-Video (PAL/ NTSC)
YPbPr	1 X YPbPr (HD component signal)
VGA1~VGA2	2 X VGA (PC analog signal)
DVI	1 X DVI (PC digital signal)
HDMI	1 X HDMI (HD digital signal)
EXT.	1 X Extended input port

Remark:

the extended input port (EXT.) can be Video, SDI / HD-SDI /3G-SDI or VGA / DVI / HDMI.

2) Audio input signals (**AUDIO / AD1, AD2**)

LVP605 supports 5 channels of stereo audio input signals, among which 3 channels are DVI (only when the input signal is HDMI), HDMI and SDI and the other 2 channels (AD1 and AD2) are external audio input signals. Audio input signals for AD1 and AD2 can be configured to match the video input signals correspondingly and switching between AD1 and AD2 is synchronous to that between the video inputs.

3) Video output signals

Port	Description
VGA OUT	1 X VGA (analog RGB signal output, can be connected to a monitor for monitoring; this port is highly recommended to use when operating or setting up LVP605)
DVI OUT1 / DVI OUT2	2 X DVI (same content will be output from these two digital ports, can be connected to 2 sending cards or 2 external sending boxes)
SDI / HD-SDI / 3G-SDI (OUT)	1 X SDI (SDI loop output, only available when the extended input port is SDI / HD-SDI / 3G-SDI)
DVI Loop OUT	1X DVI (DVI loop output)

4) Audio output signal (**AUDIO / OUT**)

This port is used to output an audio signal which corresponds to the selected video signal.

5) Other ports

RS232 In (serial communication port): used to connect the RS232 port of PC to operate LVP605 by software control.

RS232 LOOP: used to connect other units of LVP605 via RJ45 cables so that all these units can be controlled by one PC.

3-3 Connection diagram

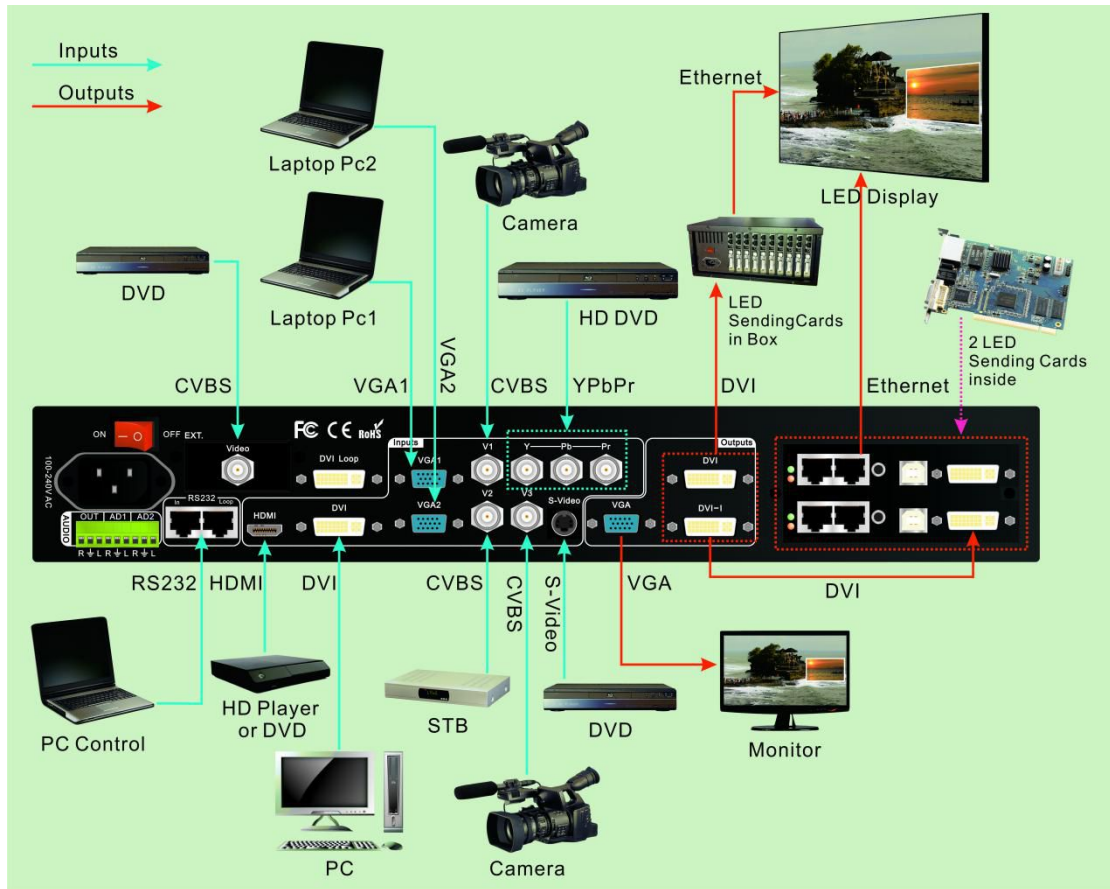

Figure 3-2 Connection diagram

Chapter 4 Front panel

4-1 Front view

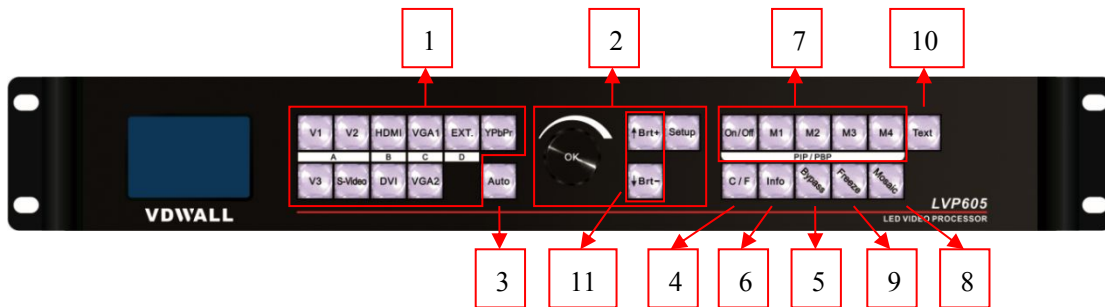

Figure 4-1 Front view

1) Input select buttons

Input select buttons (**V1**, **V2**, **V3**, **S-Video**, **DVI**, **VGA1**, **VGA2**, **YPbPr**, **EXT.**): Select the input signal.

2) Setup buttons

Setup button (**Setup**, **↑**, **↓**, **Knob**): Set up output image parameters.

3) VGA automatic adjustment button

VGA automatic adjustment button (**Auto**): Automatically adjust VGA input signal.

4) Seamless switching or Fade-in / Fade-out

Seamless switching or Fade-in/Fade-out (**C / F**): Select the switching effect between two different input signals. The effects include seamless switching (CUT), Fade-in / Fade-out (time can be set as 0.5S, 1S or 1.5S) and blending.

5) PC signal bypass output

PC signal bypass output (**Bypass**): Switch between part and full display of PC signal. The indicator shows the current state of the input signal.

6) PC signal bypass output

Information display (**Info**): Displays current settings and related information of LVP605.

7) PIP / PBP button

PIP / PBP button (**On / Off, M1, M2, M3, M4**): **On / Off**: press this button to turn on/off **PIP/PBP** function. When the indicator is on, press input signal buttons to select two signals (have to be in different channels) or the same signal for PIP / PBP.

M1, M2, M3, M4: stand for 4 customizable PIP/PBP display modes.

8) Mosaic

Mosaic: Turn on / off mosaic function (multiple units of LVP605 connected in parallel). The indicator shows the current state of mosaic.

9) Freeze

Freeze: Turn on / off freeze function.

10) Text overlay

Text overlay (**Text**): Overlay the current image with text, logo, flash and etc.

11) Brightness adjustment

Brightness adjustment (**Brt+**, **Brt-**): Adjust output brightness.

4-2 Button instructions

LVP605 has 25 panel buttons and 1 knob, which are in operation mode when LVP605 starts to work. The functions of these buttons are as follows:

1) Input signal select

Buttons	Description
V1, V2, V3	Select a composite signal from 3 BNC ports
S-Video	Select a S-Video signal (PAL / NTSC)
YPbPr	Select a YPbpr signal
VGA1, VGA2	Select a PC analog signal from 2 VGA ports
DVI	Select a PC digital signal
HDMI	Select a HDMI signal
EXT.	Select a signal from the extended port (for example: SDI / HD-SDI / 3G-SDI)

To press above buttons will lead to switching of their audio signals correspondingly, which are output from AUDIO OUT.

When selecting a input signal, its information is displayed in the first line on the LCD screen, for example: "Input: HDMI". The second line displays the current state of this signal: if there is no signal available, a message "no signal" appears, in the meantime the indicator flickers and the screen is blank; if there is a valid signal, it displays its format, such as "1080p_60Hz".

Input= HDMI
1080p_60Hz
Cut

Remark:

if the extended input port (EXT.) is VGA/DVI/HDMI, the input signal for this port needs to be confirmed by dial switch, which means when dial switch is on "VGA", the input signal for EXT. is VGA, and when it is on "DVI", the input signal is DVI / HDMI.

2) Brightness adjustment

Button	Description
BRT -	Lower output brightness until 0 minimally.
BRT +	Increase output brightness until 64 or 100 maximally.

LVP605 supports 32-level output brightness adjustment. Adjustment range includes “0~64” and “0~100”, according to “brightness level”. The factory default of adjustment range is 0~64: 0 is the lowest value and 64 is the highest. To make sure of full grey scale of output image, the default of brightness is usually set as 64.

3) VGA automatic adjustment

When the current input source of LVP605 is a valid VGA signal, to press this button will automatically adjust sampling parameters of the VGA signal, so that the output image is clear and complete.

This operation is normally performed when a new VGA source is connected. Time taken for this automatic adjustment is different, depending on the state of signal source, but normally it's less than 1 minute. Sometimes it's necessary to perform several times until the output image is clear, complete and stable.

4) Information display (Info)

Press this button, 24 items of the current settings and related information can be displayed. Before quitting information display, press “Info” again and the next item is displayed.

5) Seamless switching / Fade-in/Fade-out/Blending (C/ F)

LVP605 can realize seamless switching and fade-in / fade-out between or blending of any two signals in different channels. There is a short moment of blank screen when switching signals in the same channel.

A	B	C	D
V1, V2, V3, S-Video	DVI, HDMI	VGA1 VGA2	EXT.

Seamless switching (Cut): the third line on the LCD screen shows “CUT”, in this mode, switching is seamless. When LVP605 starts to work, signal switching defaults to be seamless.

Fade-in / Fade-out (Fade): the third line on the LCD screen shows “fade=1.0s”, in this mode, switching is fade-in/fade-out. Time for fade-in / fade-out can be set as 0.5S, 1S or 1.5S.

Blending: the LCD screen shows that the current signal is background, when selecting another signal from a different channel, two signals will blend. Press any signal button of these two again, this signal will quit from blending and be displayed independently. During this process, the effect is fade-in / fade-out.

Remark:

1. YPbPr does not take part in seamless switching or fade-in / fade-out, which means there is a short moment of blank screen when any signal is switched to YPbPr. It can't be used for blending either.
2. During blending, it is only allowed to perform signal switching. If there is need to perform other operations, it is necessary to press "C/F" to quit blending at first.

6) PIP function (**PIP / PBP: On / Off, M1, M2, M3, M4**)

The PIP / PBP function of LVP605 allows for locating another window in or beside the current image and size and location of this window can be set at random. PIP source can be the same as the current signal source or another source in a different channel. Here we call the current image and another image overlapped as "background" and "PIP" accordingly. The following is how to perform this function:

Enter PIP mode: press "On / Off", the indicator is on and LVP605 starts to enter PIP mode. Press a signal button to select a signal as PIP source and sources for background and PIP are displayed on the LCD screen:

Background: V1 PAL PIP: VGA 1280X1024_60Hz

Change PIP source: in PIP mode, press a signal button and this signal is selected as the source for PIP.

Change background source: quit PIP mode at first and then press a signal button, this signal is selected the source for background. Restart PIP mode to select new source for PIP.

Change PIP mode: LVP605 supports 4 customizable PIP modes. In each mode, size and location of background and PIP can be set

differently. When PIP mode starts to work, press a PIP mode button (M1, M2, M3, M4) to select the mode accordingly.

7) Full / part display (**Bypass**)

Press this button to switch between full and part display.

This function only works when the current selected signal is PC signal (VGA1 / VGA2 / DVI / HDMI). If other signals, they can't be switched to part display.

State	Description
Full	Full display: the input image is compressed and fully displayed on the LED screen and the indicator is off.
Part	Part display: the input image is not compressed, thus only a part of it can be displayed on the LED screen and the indicator is on.

Remark:

when the width and height of input image is lower than That of LED screen (output width and height), part display is invalid.

8) Freeze

Press the button, the indicator is on and the current signal is frozen. Press the button again or switch to another signal to quit "Freeze".

9) Multiple units connected in parallel (**Mosaic**)

Only when the current input signal is DVI, press this button, the indicator is on and mosaic function of LVP605 starts to work. Press the button again, the indicator is off and LVP605 quits "Mosaic".

Remark: in following conditions, mosaic function can't work,

- 1.The input signal selected is not DVI.
- 2.BYPASS is on.
- 3.The input resolution of DVI signal is different from output resolution of LVP605.

10) Text overlay (**Text**)

LVP605 allows for overlapping text, logo or flash on the current image: press "Text" and select a signal as source for text overlay. Text can be made by office software like Powerpoint.

Chapter 5 Settings

The following settings should be completed by professional technicians. Normal users should not try to change following settings unless they have received technical training.

3 categories of settings of LVP605 are opened to technicians. They can change those settings according to the specific requirements.

Category	Item
User settings	Output image parameters, text overlay, brightness / saturation/sharpness, audio, hot spare, factory settings.
Mosaic settings	Input parameters, output parameters, Mosaic mode
PIP / PBP settings	Background and PIP parameters

5-1 User settings

Category		Item	
1	Language	1	<i>Language 语言</i>
2	Output image	2	<i>Output Format</i>
		3	<i>DVI EDID</i>
		4	<i>Out_Hori_Width</i>
		5	<i>Out_Hori_Start</i>
		6	<i>Out_Vert_Height</i>
		7	<i>Out_Vert_Start</i>
		3	Text overlay
9	<i>Threshold Red</i>		
10	<i>Threshold Green</i>		
11	<i>Threshold Blue</i>		
4	Brightness / Saturation / Sharpness	12	<i>Brightness</i>
		13	<i>Saturation</i>
		14	<i>Sharpness</i>
5	Audio	15	<i>AD1 Config</i>
		16	<i>AD2 Config</i>
6	Hot spare	17	<i>Hot spare < V1→V3></i>
		18	<i>Hot spare <V2→S-Video></i>
		19	<i>Hot spare < HDMI→DVI></i>
		20	<i>Hot spare <VGA1→VGA2></i>
7	Test pattern	21	<i>Test pattern</i>
		22	<i>Device ID</i>
8	Factory settings	23	<i>ADC calibration</i>
		24	<i>Grey scale</i>
		25	<i>Brightness level</i>
		26	<i>Video stabilization</i>
		27	<i>EXT. module</i>
		28	<i>Device init.</i>

1. Enter settings menu

Enter settings: while in operation mode (make sure PIP and Mosaic are switched off), press “Setup” and “OK” to reach the first item in settings menu.

Quit settings: while in settings menu, press “Setup” again to quit settings.

Functions of the knob and buttons in settings are:

Button		Function
Knob	Rotate speed	Step value in proportion to rotate speed.
	Rotate clockwise	Decrease value or select previous value.
	Rotate anticlockwise	Increase value or select next value.
	Press	Save adjusted or selected value.
↑		Switch to the previous item.
↓		Switch to the next item.
Setup		Enter or quit settings.

When entering settings, the LCD screen displays related information of settings as shown in the picture:

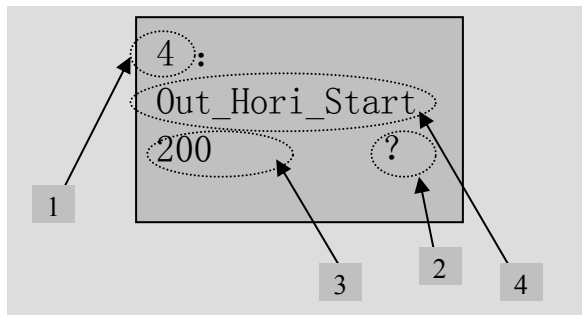

Figure 5-1 Settings

As shown in the picture above, there are 5 sectors on the LCD screen:

Sector	Description
1	Item number.
2	?: if needs to save the adjustment; Or !: new adjustment is saved and starts to take effect.
3	New adjustment
4	Item name

2. Select language

No.1: "Language 语言"

The first item in settings is: "Language 语言". LVP605 supports Chinese and English, rotate the knob to select and press it to save the setting.

3. Output image settings

LVP605 can output image from the VGA OUT and 2 DVI OUT ports. There are 17 output formats which can be selected in item no.2 “Output Format”:

	Output Format
1	1024×768_60
2	1024×768_75
3	1280×1024_60
4	1280×1024_75
5	1600×1200_60
6	1920×1080_50
7	1920×1080_60
8	1366×768_60
9	1440×900_60
10	2048×1152_60
11	2560×816_60
12	2304×1152_60
13	1920×1200_60
14	1200×1600_60
15	1080×1920_60
16	1536×1536_60
17	Custom Output Format

No.2: “Output Format”

Rotate the knob to select a output format and press it to save.

For example: “1280×1024_60” means that the output resolution of LVP605 is 1280×1024 and field frequency is 60Hz.

Please select a format with resolution the same as or higher than the resolution of LED screen.

No.3: “DVI EDID”

To make input image output pixel-by-pixel, now LVP605 series LED video processors offer customizable EDID (Extended Display Identification Data) of DVI source.

There are 2 types of EDID: fixed and customizable.

Fixed EDID	1024x768_60	1024x768_75	1280x1024_60
	1280x1024_75	1600x1200_60	1920x1080_50
	1920x1080_60	1366x768_60	1440x900_60
	2048x1152_60	2560x816_60	2304x1152_60
	1920x1200_60	1200x1600_60	1080x1920_60
	1536x1536_60		
Customizable EDID	EDID width: customizable horizontal pixel of resolution		
	EDID height: customizable vertical height of resolution		
	EDID frequency: customizable frequency of resolution		

Select item no.3 “DVI EDID” in settings menu, rotate the knob to find “Custom” and press “OK”, horizontal pixel, vertical pixel and frequency of resolution can be customized according to customers’ specific requirements. Press “OK” to save the settings and then “Setup” to apply, customizable EDID settings are finished.

No.4~No.7: “Output image parameters”

Pixel size of a LED screen can be arbitrary, so the output image size of LVP605 has to be exactly the same as that of LED screen so that the image can be fully displayed, as shown in the following picture:

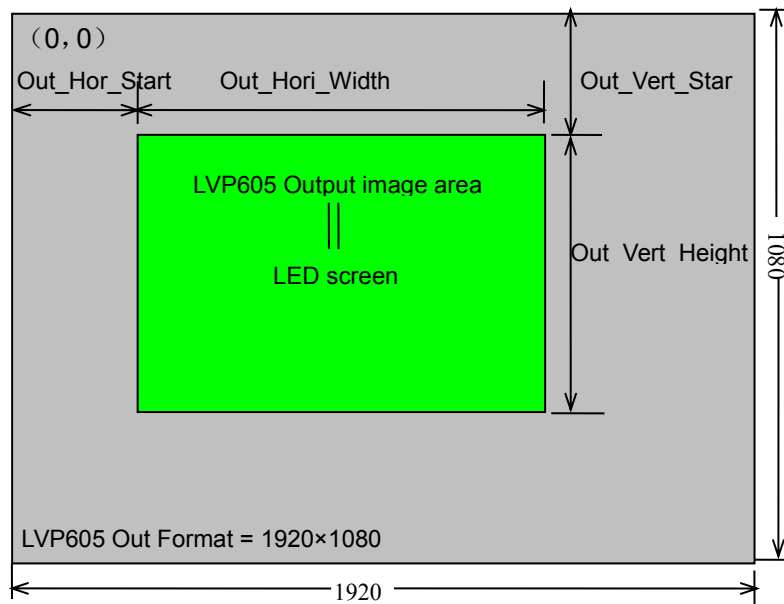

Figure 5-2 Output image parameters

As shown in the above picture: the size and location of output image of LVP605 can be defined in 4 parameters:

Item No.	Item Name
4	Out_Hori_Width
5	Out_Hori_Start
6	Out_Vert_Height
7	Out_Vert_Start

Remark:

parameters can be changed by rotating the knob and the rotating speed decides the step value. When setting the parameters, the size and location of output image can be previewed in a rectangular frame and parameters can be saved by pressing the knob.

4. Text overlay

Item No.	Item Name
8	Text Mode
9	Threshold Red
10	Threshold Green
11	Threshold Blue

No.8: "Text Mode"

Text mode (keying) of LVP605 can be customized as higher or lower than threshold. If lower than threshold, the part of the text signal, of which the RGB value is lower than threshold, will be overlapped to the background image and the other part is filtered. Otherwise, if higher than threshold, the part of which the RGB value is higher than threshold will be overlapped to the background image.

No.9~11: "Threshold R / G / B"

RGB value can be set as one between 0 and 248.

The following is an example of text overlay and its text file is made by PowerPoint:

8	Text Mode	<Threshold
9	Threshold R	248
10	Threshold G	248
11	Threshold B	248



Figure 5-3 Text overlay

5. Brightness / Saturation / Sharpness

LVP605 supports customizable brightness, saturation and sharpness:

Item No.	Item Name	Definition
12	Brightness	Adjustment range includes “0~64” and “0~100”, according to “brightness level”. The factory default of adjustment range is 0~64 and brightness is 64. “Brightness level” can be set in factory settings.
13	Saturation	Adjustment range: 0~100, default: 50
14	Sharpness	Normal or sharp, default: normal

Remark:

- To make sure of full gray scale of output image, these items should be set as defaulted.
- Setting of saturation only works for V1, V2, V3, S-Video, YPbPr, SDI and HDMI.

6. Audio Configuration

LVP605 supports 5 channels of stereo audio input signals, among which 3 channels are DVI (only when the input signal is HDMI), HDMI and SDI and the other 2 channels (AD1 and AD2) are external audio input signals. Audio input signals for AD1 and AD2 can be configured to match the video input signals correspondingly and switching between AD1 and AD2 is synchronous to that between the video inputs.

Item No.	Item Name	Definition
15	AD1 Config	Audio configuration of AD1
16	AD2 Config	Audio configuration of AD2

Remark:

AD1 and AD2 can't be configured to match the same Input signal.

7. Hot spare

LVP605 supports hot spare of input signals. When the current input signal is lost, LVP605 will switch to the spare signal automatically to avoid image interruption caused by the fault of signal source.

Item	Item Name
17	Hot spare < V1→V3>
18	Hot spare <V2→S-Video>
19	Hot spare < HDMI→DVI>
20	Hot spare <VGA1→VGA2>

As shown in the above table, for example, when switching on “Hot spare <V1→V3>”, if V1 signal is lost, LVP605 will switch to V3 automatically.

8. Test pattern

LVP605 can generate 36 test patterns for testing of LED screen.

“0” means the test pattern is switched off, while “1~36” stand for 36 test patterns.

Only when the current selected input signal works properly the test pattern can be output, otherwise there is no test pattern output.

9. Factory settings

The following settings are factory settings, any improper settings or operation will lead to failure of LVP605. It is highly recommended to operate under the guidance of the manufacturer.

No.22: “Device ID”

This setting is used to number multiple units of LVP605 when they are connected in parallel. Parameter range: 1~255。

No.23: “ADC Calibration”

Some problems such as color cast or extreme darkness may appear when analog signals are input to a processor of which white balance is not calibrated yet. LVP605 can automatically calibrate the white balance according to the input analog signals (CVBS, S-Video, YPbPr, VGA) to solve the above problem. The following is how to run the calibration: switch to an analog input signal, when the processor detects it and outputs it to an LED display, find the item No.22 “Device ID” and press “V1” 5 times to reach the item No.23 “ADC Calibration” and then press the knob to run the calibration.

Remark:

before LVP605 leaves the factory, its white balance has been calibrated using standard signals, therefore please use this item with caution.

No.24: “Grayscale”

To reduce noise of low grayscale images, the LED display system normally will remove the low grayscale part from input signals, but this will also bring information loss of images, especially dark images like night scenes.

LVP605 can amend this by adjusting the parameter in “Grayscale”, of which the adjustment range is 0—100. When some information of dark images is lost, to add the value of “Grayscale” will bring back the lost information and fully display the image on the LED display.

To make sure of full grayscale of output image, the default is normally set as 50.

No.25: “Brightness level”

There are 2 different brightness levels: “0~64” and “0~100”. The factory default is 0~64, the lowest value in both two levels is 0, while the highest is different: “0~100” has higher brightness. Because of two different levels, even the same value may mean different brightness. Customers should select a suitable level according to specific application. If “brightness level” is changed, the newly selected level will be saved, even when “Device init.” is performed.

Remark:

when multiple units of LVP605 are connected in parallel, their “Brightness level” should be the same, or their output brightness will be different.

No.26: “Video stabilization”

When CVBS/S-Video/HDMI/SDI is interlaced (for example: 1080i) and used as PIP, because of the limit of LVP605, video jitter might appear and this problem can be solved by “Video stabilization”.

Find item no.22 “Device ID”, press “V1” 5 times and “↑” to switch to item no.23 “Video stabilization”, rotate the knob to select “On” and press it to save the setting.

No.27: “EXT. module”

When the extended input module is changed, this setting is used to make the new module work properly.

Find item no.22 “Device ID”, press “V1” 5 times and “↑” to switch to item no.24 “EXT. module”, rotate the knob to select and press it to save the setting. It is necessary to restart LVP605 then to make it work.

No.28: “Device init”

Find item no.22 “Device ID”, press “V1” 5 times and “↑” to switch to item no.28 “Device init.”, rotate the knob to select “Confirm” and press it to restore LVP605 to factory settings. It is necessary to restart LVP605 then to make it work.

5-2 PIP / PBP settings

Category		Item	
1	Background output settings	1	Main_Hori_Width
		2	Main_Hori_Start
		3	Main_Vert_Height
		4	Main_Vert_Start
P	PIP output settings	5	PIP_Hori_Width
		6	PIP_Hori_Start
		7	PIP_Vert_Height
		8	PIP_Vert_Start
3	PIP mode switching effect	9	PIP switching mode

There are 4 PIP / PBP display modes, in each mode background and PIP settings can be customized.

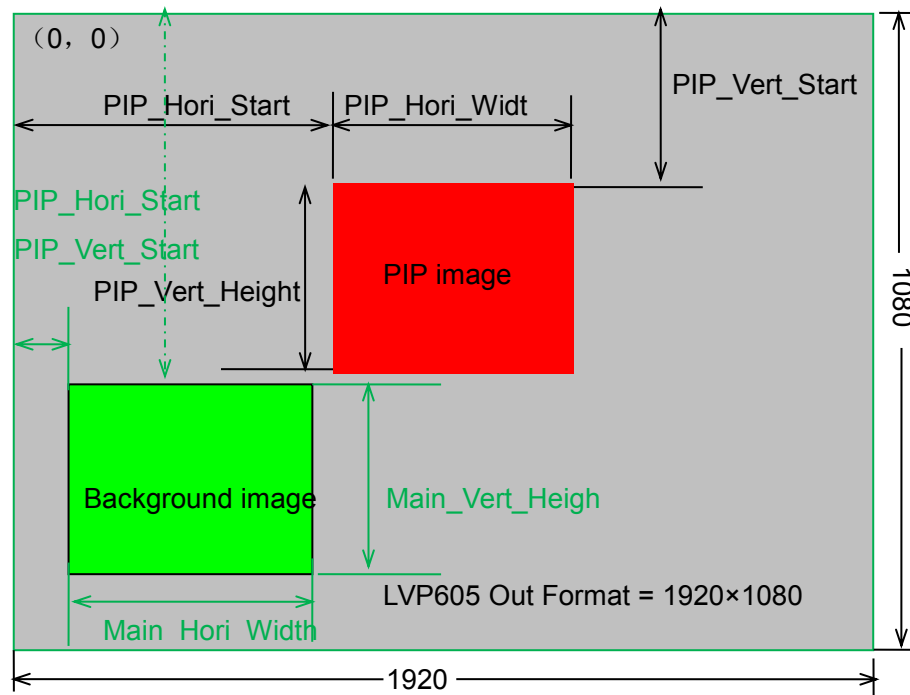

Figure 5-4 PIP / PBP settings

As shown in the above picture: background and PIP settings are defined by 8 groups of parameters:

Item No.	Item Name
1	Main_Hori_Width
2	Main_Hori_Start
3	Main_Vert_Height
4	Main_Vert_Start
5	PIP_Hori_Width
6	PIP_Hori_Start
7	PIP_Vert_Height
8	PIP_Vert_Start

PIP switching mode: PIP signal switching can be seamless or fade-in / fade-out (0.5S / 1S / 1.5S).

How to change PIP / PBP settings:

Enter PIP / PBP settings: when PIP/PBP starts to work, press "Setup" and then the knob to reach the first item in the settings. The LCD screen will display:

1.	
Main_Hori_Width	
1216	?
PIP / PBP mode=1	

Switch PIP mode: press "M1, M2, M3 or M4".

Switch setting: press "↑" and "↓".

Change parameters: parameters can be changed by rotating the knob and the rotating speed decides the step value. When setting the parameters, the size and location of output image can be previewed in a rectangular frame and parameters can be saved by pressing the knob.

Quit PIP / PBP: during PIP / PBP mode, press "Setup" to quit.

5-3 Mosaic settings

Category		Item No. and Name	
Input image settings	1	Out_Hori_Width	
	2	Out_Hori_Start	
	3	Out_Vert_Height	
	4	Out_Vert_Start	
	5	In_Hori_Width	
	6	In_Hori_Start	
	7	In_Vert_Height	
	8	In_Vert_Start	
	9	Mosaic Mode	

The maximum output resolution of LVP605 is 2304×1152 or 2560×816 and it takes 2 sending cards to drive a LED screen with such resolution and that's why LVP605 has 2 sending card slots; If the resolution of LED screen is above the maximum output resolution of LVP605, the screen could be "divided" into several parts and each part can be driven by one LVP605, therefore multiple units of LVP605 are connected in parallel could drive the full screen.

Using frame synchronization, LVP605 overcomes problems like misalignment or delay in ultra-large image mosaic and therefore it could realize real-time, clear and fluent display effects.

LVP605 supports multiple unit mode, which is specially used for ultra-large LED screen. For example, if the output resolution of a LVP605 is set as 1920 X 1080, then 2 units of LVP605 in parallel can drive a LED screen with resolution of 3840×1080.

The following is an example of 4 units of LVP605 which are used for 2 X 2 mosaic and details about how to perform it.

A LED screen with resolution of 3456×1920 can be divided into 4 smaller screens with resolution of 1728×960 and each part can be controlled by one LVP605, so 4 units of LVP605 in parallel can allow the big screen (3456 X 1920) to display a full image.

#1(1728 x 960)	#2(1728 x 960)
#3(1728 x 960)	#4(1728 x 960)

The following is the system topology:

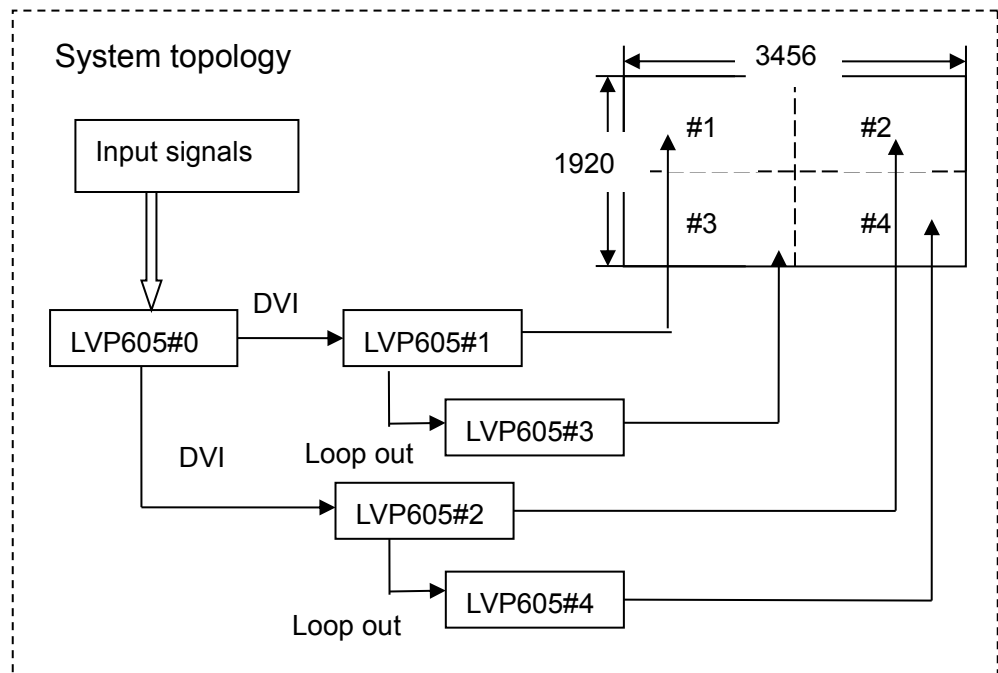

Figure 5-5 system topology

As shown in the above picture, all input signals are connected to LVP605#0 as the master control and output from 2 DVI ports to #1 and #2, and then looped out to #3 and #4 accordingly. The output image will be cropped and scaled by #1, #2, #3 and #4, and then finally is displayed as a full image on 4 LED screens.

It is required to set output parameters of each LVP605 to run multiple unit mode:

Item No.	Item Name
1	Out_Hori_Width
2	Out_Hori_Start
3	Out_Vert_Height
4	Out_Vert_Start
5	In_Hori_Width
6	In_Hori_Start
7	In_Vert_Height
8	In_Vert_Start
9	Mosaic Mode

Remark:

to make sure of uniformity of output images when running “Mosaic”, settings like brightness, saturation, sharpness and grayscale of each LVP605 should be the same.

Enter mosaic settings: when running “Mosaic”, press “Setup” and the knob to enter related settings.

Quit mosaic settings: press “Setup” again to quit.

Parameters of 5 units of LVP605 are set as follows:

Item No. and Name	Parameters of 5 units of LVP605				
	#0	#1	#2	#3	#4
1 <i>Out_Hori_Width</i>	1920	1728			
3 <i>Out_Vert_Height</i>	1080	960			
<i>Out Format</i>	1920×1080				
5 <i>In_Hori_Width</i>	1920	960	960	960	960
6 <i>In_Hori_Start</i>	1080	540	540	540	540
7 <i>In_Vert_Height</i>	0	0	960	0	960
8 <i>In_Vert_Start</i>	0	0	0	540	540
9 <i>Mosaic Mode</i>	No Sync	Sync			

To make sure of complete synchronization of each output image, please note following settings:

1. When running “Mosaic”, the selected input signal of #1, #2, #3 and #4 must be DVI and it can't be switched to another one.
2. The “Out Format” of each LVP605 should be the same.
3. Too much use of DVI loop out may cause signal attenuation and lead to signal instability, so please try to avoid it.

No.1~4: "Output image parameters"

These 4 parameters correspond to No.4~7 in user settings.

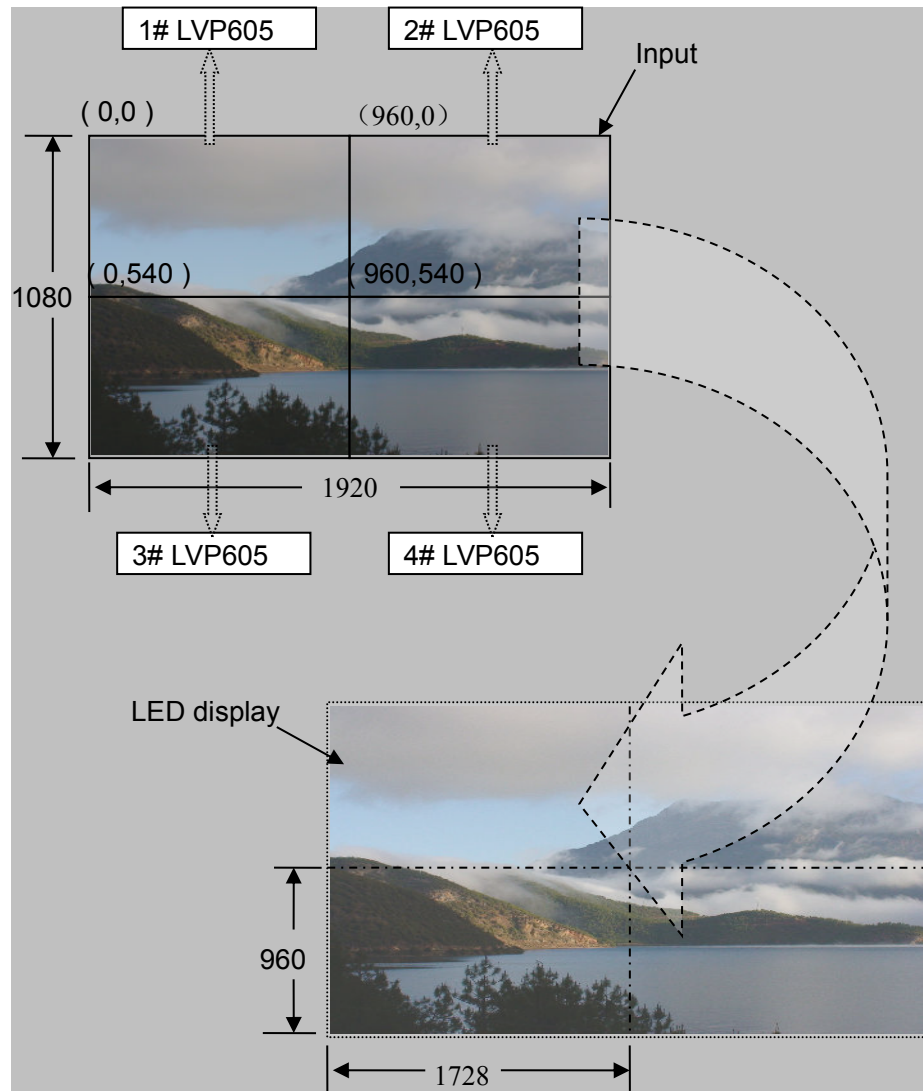

Figure 5-6 Output image parameters

No.5: "In_Hori_Width"

As shown in picture 5, the input image with resolution of 1920 X 1080 is horizontally divided into 2 parts, so the input width of each LVP605 should be set as:

$$\text{In_Hori_Width} = 960$$

No.6: “In_Hori_Start”

As shown in picture 5, the input starting point of each LVP605 should be set as:

- 1# LVP605 In_Hori_Start = 0
- 2# LVP605 In_Hori_Start = 960
- 3# LVP605 In_Hori_Start = 0
- 4# LVP605 In_Hori_Start = 960

No.7: “In_Vert_Height”

As shown in picture 5, the input height of each LVP605 should be set as:

In_Vert_Height = 540

No.8: “In_Vert_Start”

As shown in picture 5, the input starting point of each LVP605 should be set as:

- 1# LVP605 In_Vert_Start = 0
- 2# LVP605 In_Vert_Start = 0
- 3# LVP605 In_Vert_Start = 540
- 4# LVP605 In_Vert_Start = 540

No.9: “Sync Mode”

It offers options of “No Sync Mosaic” and “Sync Mosaic”. “Sync Mosaic” ensures that display of all output images is completely real-time and synchronous, while “No Sync Mosaic” offers better compatibility and is usually used for debugging of mosaic.

Chapter 6 Specifications

Inputs		
Number / Type	3×Video 1×S-Video 1×YPbPr 2×VGA (RGBHV) 1×HDMI (VESA / CEA-861) 1×DVI (VESA) 1×EXT. (Extended)	
Video system	PAL / NTSC	
Composite Video Amplitude / Impedance	1V (p_p) / 75Ω	
S-Video Amplitude / Impedance	Y: 1.0V (p_p) / 75Ω, C: 0.35V (p_p) / 75Ω	
VGA Format	PC (VESA)	≤2048x1152_60Hz
VGA Amplitude / Impedance	R、G、B = 0.7 V (p_p) / 75Ω	
DVI Format	PC (VESA)	≤2304x1152_60Hz
HDMI Format (HDCP)	PC (VESA)	≤2304x1152_60Hz
	HDMI1.3 (CEA-861)	≤1920x1080p_60Hz
YPbPr Format	SD/HD (CEA-861)	≤1920x1080P_60Hz
YPbPr Amplitude / Impedance	Y= 1.0V (p_p)/75Ω Pb= 0.35V (p_p) / 75Ω Pr= 0.35V (p_p) / 75Ω	
SDI / HD-SDI / 3G-SDI format	SMPTE259M-C SMPTE 292M SMPTE 274M/296M SMPTE 424M/425M	480i_60Hz 576i_50Hz 720p、1080i、1080p
Audio Scope / Impedance	2.0Vp-p / 10KΩ	
Input Connectors	VGA: 15-pin D_Sub (Female) DVI: 24+1 DVI_D YPbPr: BNC×3 Video: BNC S-Video: 4pin mini DIN (Female) SDI: BNC	
Outputs		
Number / Type	1×VGA (RGBHV) 2×DVI	

VGA / DVI Format	1024×768_60Hz / 75Hz 1280×1024_60Hz / 75Hz 1600×1200_60Hz 1920×1080p_50Hz / 60Hz 1366×768_60Hz 1440×900_60Hz 2048×1152_60Hz 2560×816_60Hz 2304×1152_60Hz 1920×1200_60 Hz 1200×1600_60 Hz 1080×1920_60 Hz 1536×1536_60 Hz Customizable output format (maximum horizontal pixel: 3840 or maximum vertical pixel: 1920)
VGA Amplitude / Impedance	R、G、B = 0.7 V (p_p) / 75Ω
Output Connectors	VGA OUT: 15-pin D_Sub (Female) DVI OUT1: 24+5 DVI_I DVI OUT2: 24+1 DVI_D
Others	
Control	Panel Buttons
Input Voltage	100-240VAC 50/60Hz
Maximum Power Consumption	≤20W
Environment Temperature	5-40 °C
Environment Humidity	15-85%
Product Size	482.6mm (L) ×274mm (W) ×66.6mm (H)
Package Size	535mm (L) ×370mm (W) ×145 mm (H)
Weight (G.W.)	5.0 Kg
Weight (N.W.)	3.2Kg

Product dimension:

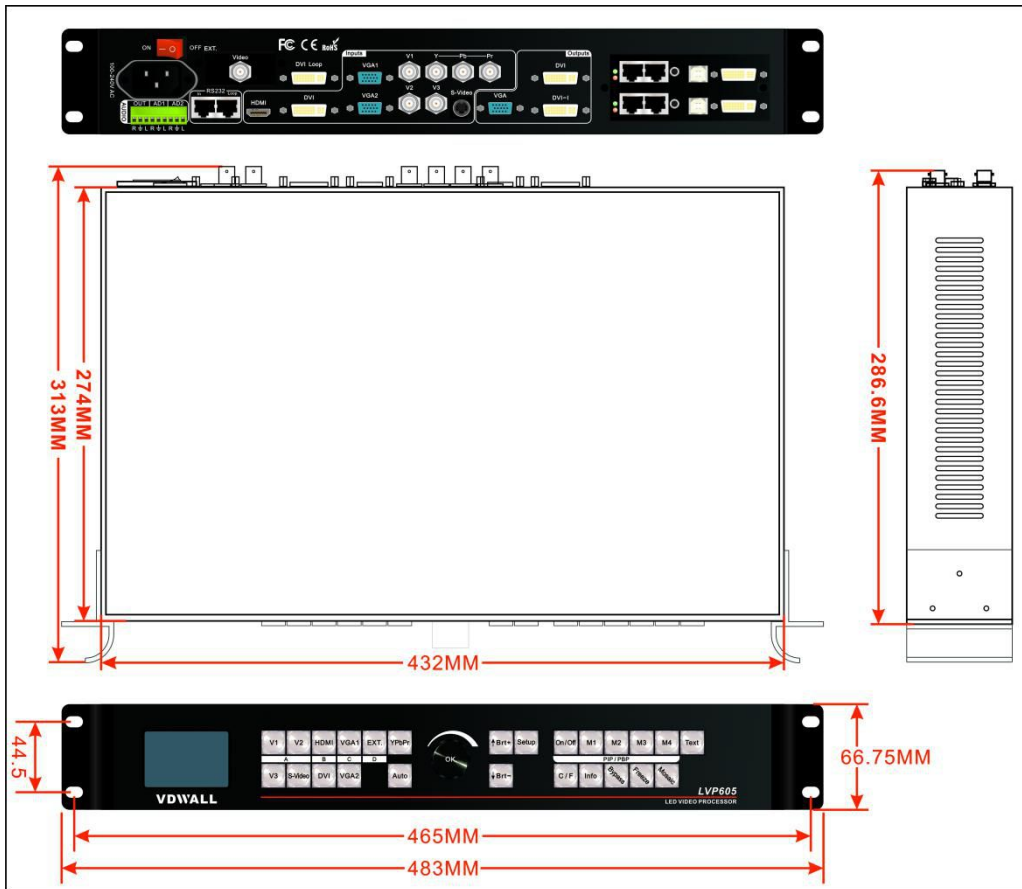
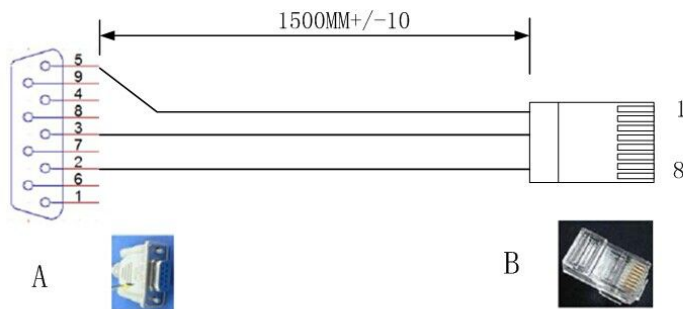

Figure 6-1 Product dimension

LVP605 RJ45 to RS232 cable



- | | |
|---|-----|
| A | B |
| 2 | 4 |
| 3 | 5 |
| 5 | 3 6 |

Note: 1.A is RS232 female connector;
 2.B is RJ45 crystal connector;
 3.Must meet safety requirements and the cable should be soft;

Figure 6-2

Chapter 7 ViewRGB LVP605 Series Control Software

LVP605 control software is used to control LVP605 by software. With this software, we can realize:

- Seamless switching or fade-in / fade-out of input signals.
- 4 customizable PIP / PBP display modes and text overlay.
- Switching on / off bypass, freeze and mosaic
- Setting parameters of LVP605.
- Timing switching of input signals.
- Fast mosaic.

7-1 Control method

LVP605 can receive control command from the software to switch input signals, change output brightness and etc. LVP605 is controlled by the software via RS232 serial port of PC.

Users can use the software to manually control LVP605 via RS232 or create a timer to automatically control LVP605.

Using this method, first connect the communication port (COM) of PC to RS232 port of LVP605 and then run the program: LVP605 Control Software.exe.

7-2 Software Interface

1. User interface

Double click to run LVP605 Control Software.exe, user interface will appear as follows:

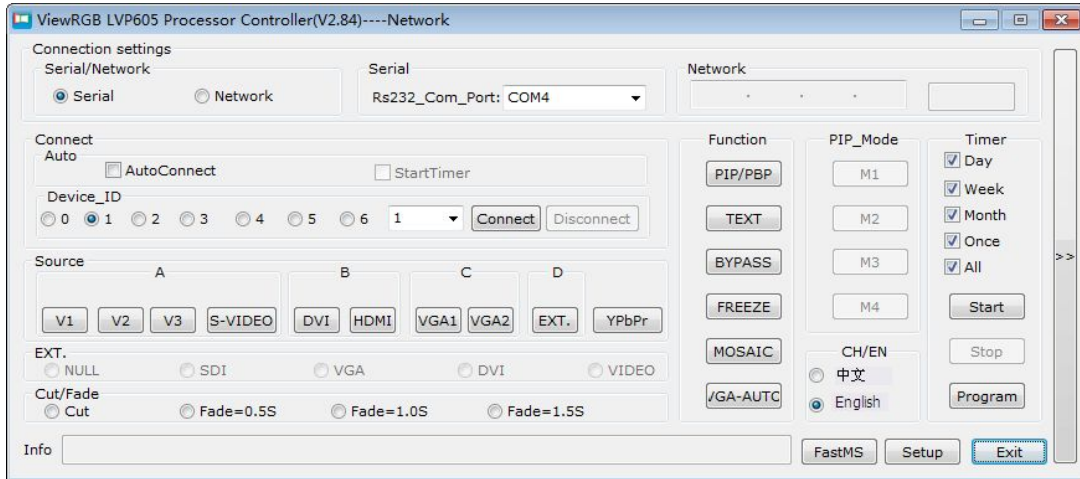

As the above picture shows, user interface consists of 8 areas:

- a) RS232 COM port configuration
- b) IP port configuration
- c) Input signal select
- d) Switching effect select
- e) Information bar
- f) Timer settings
- g) Function select
- h) PIP mode select
- i) Language select
- j) Output settings (screen setup)
- k) Multiple unit mode settings (Fast Mosaic)

1) Language select



The software offers language select: Chinese and English.

2) RS232 COM port configuration

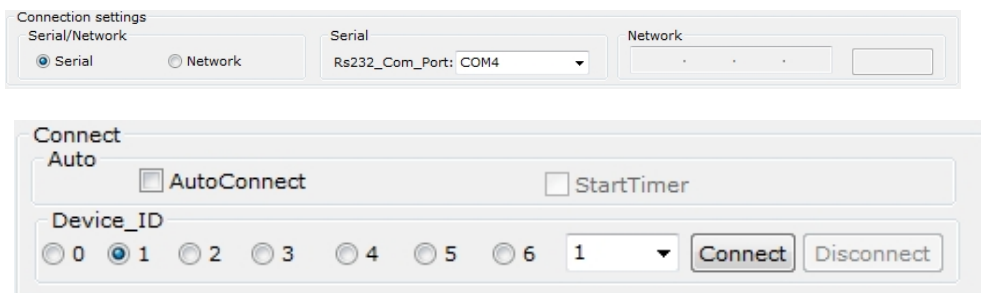

First select a COM port accordingly and then select the correct device ID. COM number can be checked in “Device Manager” of control PC as follows:

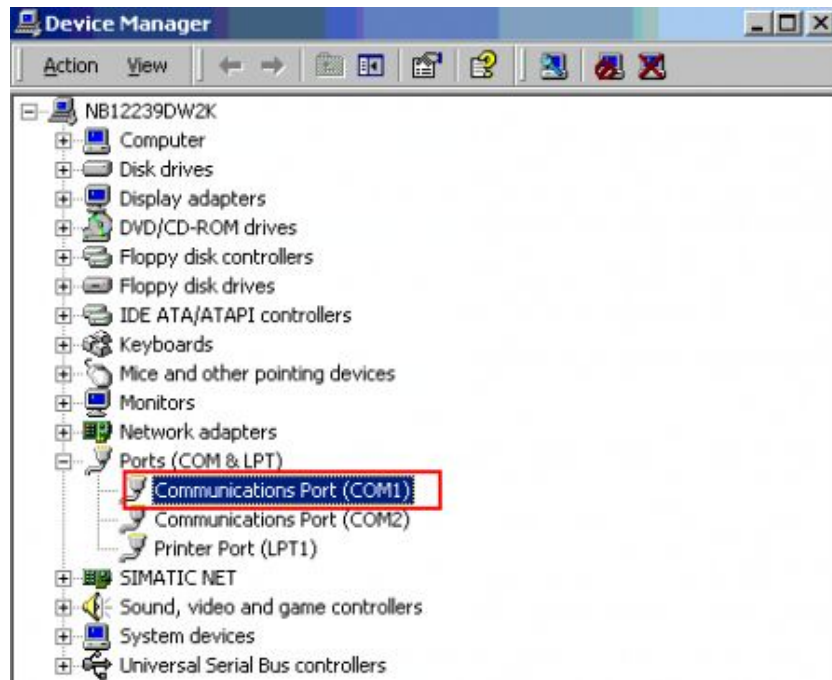

Device ID (the same as No.21 “Device ID” in user settings) selected should be the same as that of LVP605 to be controlled.

Click “Connect”, the following message appears:



Device connection successful, all functions in the interface are activated and the following message will appear in the information bar:

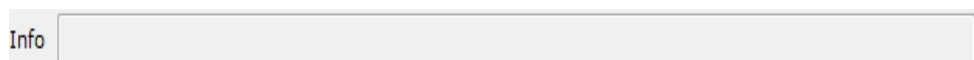

Auto start: to set whether COM port connecting and timer automatically start when turning on LVP605 next time:

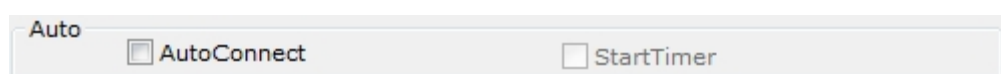

3) Signal status display and signal switching

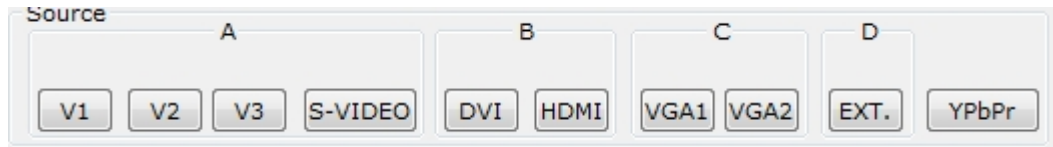

In this area, buttons and indicators correspond to those on the front panel of LVP605.

When devices are connected successfully, the software will read the current selected input signal of LVP605 and indicates it in a blue spot. If the blue spot is on all the time, it means the input signal works properly; if it flickers, it means the signal is invalid.

Signal switching can be done by clicking signal buttons directly. Information about the extended input can be checked in this area.

4) Switching effect select

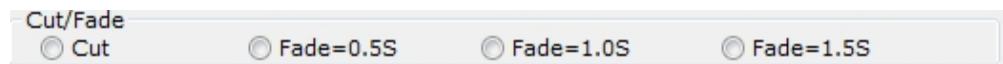

This setting is used to select the signal switching effect: seamless switching or fade-in / fade-out (0.5S, 1.0S or 1.5S).

5) Function select



In this area, we can select to use PIP, TEXT, BYPASS, FREEZE, MOSAIC or VGA-AUTO.

Display modes include signal seamless switching, fade-in /fade-out, PIP, PBP and text overlay.

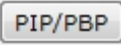
PIP: select a signal at first and then click , indicators of

PIP / PBP and PIP mode will flicker, select another signal as PIP source. If the indicator of the PIP signal is on all the time, PIP display mode will work properly. PIP or PBP display modes can be selected by pressing buttons M1, M2, M3 or M4.

When PIP is working, press  again, we can quit this operation.

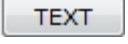
TEXT: select a signal at first and then click , the indicator will flicker, select another signal as source for text overlay, if its indicator is on all the time, TEXT will work properly.

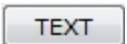
When TEXT is working, press  again, we can quit this operation.

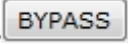
BYPASS: when the current input signal is PC signal like VGA/DVI/HDMI, press , the indicator is on and LVP605 starts to display a part of the signal, otherwise it will display the full of signal.

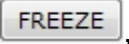
FREEZE: when displaying a signal, press , LVP605 will freeze the output image. Press it again or another signal button to switch signal, we can quit from this operation.

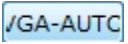
VGA-AUTO: When the current input source of LVP605 is a valid VGA signal, to press  will automatically adjust sampling parameters of the VGA signal, so that the output image is clear and complete.

6) Timer settings

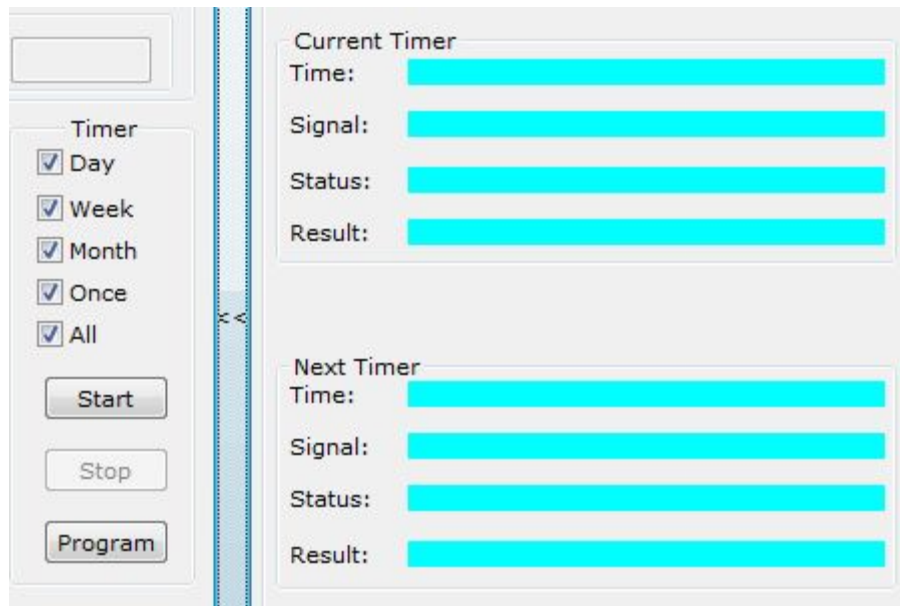

Timer of the control software can be used for timing switch of input signals of LVP605. Timer offers timing plans including “Day”, “Week”, “Month” and “Once”.

Select one or several timing plans, click “Start” and timer starts to work. If need to stop the timer, click “Stop”.

Click “Setup” to enter the interface of timer settings, we can check, add, revise or delete preset timer plans. Details can be checked in “Instructions of Timer Interface”.

LVP605 Control Software can’t be shut down, so that timer can work properly when it is started.

7) Information bar

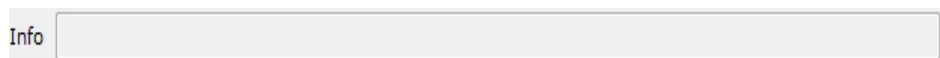

If operation fails, the reason will be displayed in the bar.

2. Output settings

In the user interface, click “屏幕设置”, the interface of output settings will appear. Users can complete output settings in this interface then.

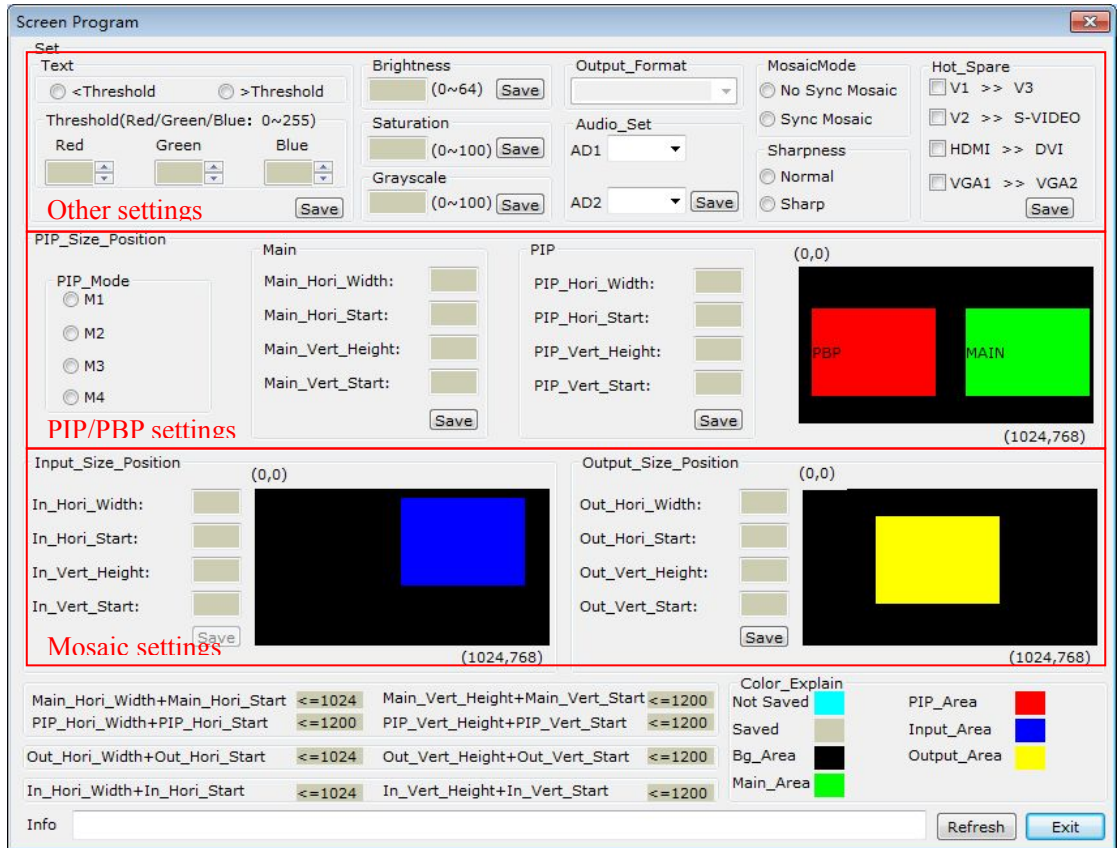

As the above picture shows, the button “Refresh” is used to update any changed settings. The information bar will display any improper settings.

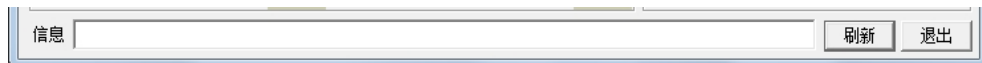

The current output resolution of LVP605 is displayed in the interface, but it can't be changed by the software control.

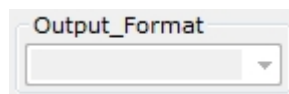

In addition, when setting parameters, the blue background means a new parameter is being input or not saved yet, while the gray background means it is saved already:

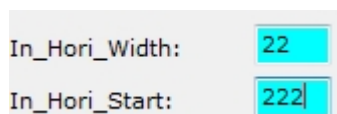

1) Input / output settings and mosaic settings

Output parameters should be set according to the resolution of LED screen. Mosaic mode and input parameters are only used for multiple unit mode. Options are provided to set whether the processor adopts synchronous or non-synchronous mosaic mode. Input parameters are used to set the location and size of the images to be captured from input image based on the actual size of the screen.

Remark:

input image parameters shall not be configured unless the following conditions are met:

- a) The selected input signal of LVP605 is DVI.
- b) The resolution of DVI input signal should be the same as output resolution of LVP605.
- c) All units of LVP605 are in Mosaic mode (the indicator of Mosaic is on).

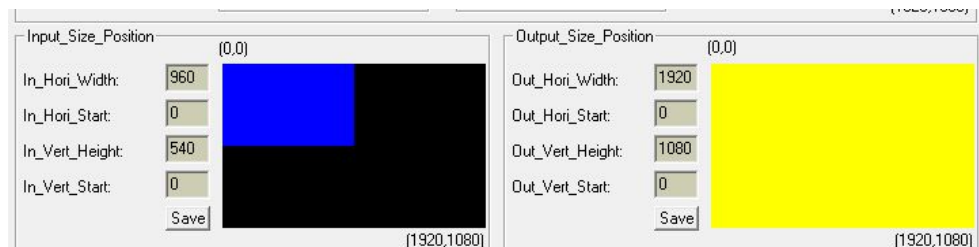
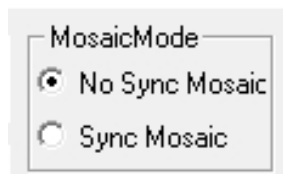

2) PIP / PBP settings(location and size of PIP windows)

This area is used to set the four PIP/PBP display modes of LVP605.

First, select a PIP mode to be adjusted, input background and PIP parameters and then click “Save” button to save the parameters.

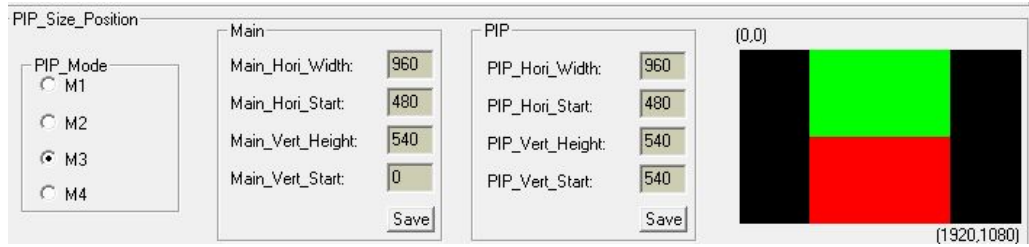

3) Text

It is used to set the red, green and blue threshold values of valid information of the text signal to be captured by the processor, also to set whether the text is higher or less than threshold values, select appropriate threshold values, click “Save” button to save them in the processor.



4) Brightness, saturation, grayscale and sharpness

This option is used to set brightness, color, grayscale, sharpness of output images. Input the desired parameters and then click “Save” button. To set sharpness, directly click “Normal” or “Sharp” to save.

Notes: the default values of brightness, color, contrast are all 50.

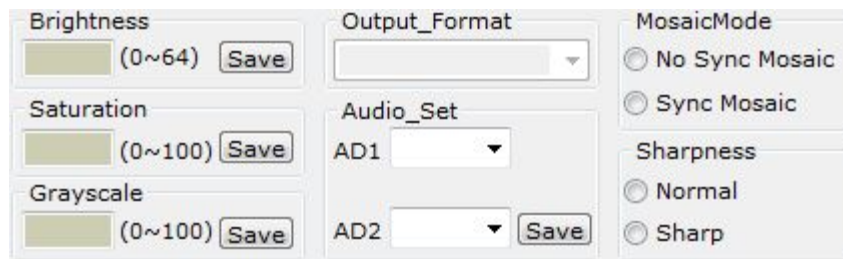

5) Audio configuration

This option is used to set AD1, AD2 audio port as the corresponding video input port, so as to realize synchronous switching of audio / video signals.

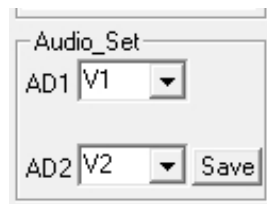

6) Hot spare

This option is used to turn on/off the hot spare function of the following four groups of input signals.

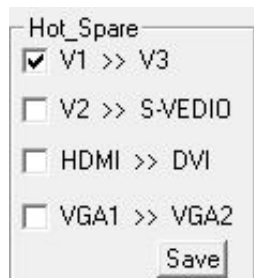

7) Timer settings

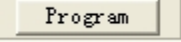
Click  in the user interface, timer setting will appear as follows:

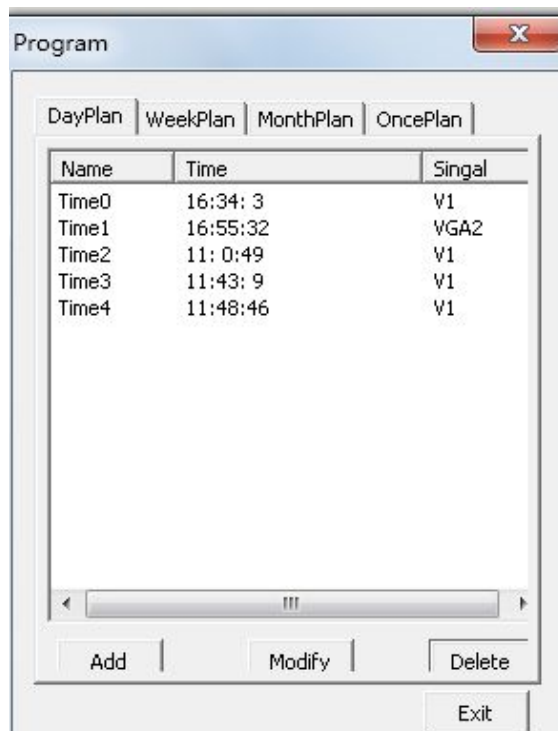

As shown in the above picture, there are two types of plans:

- ◆ Cycle Plan
- ◆ Once Plan

Cycle Plan includes:

- ◆ Day Plan
- ◆ Week Plan
- ◆ Month Plan

Users can select a plan desired.

Day Plan items define hour, minute and second;

Week Plan items define day, hour, minute and second in a week;

Month Plan items define date, hour, minute, and second in a month;

Once Plan items define year, date, hour, minutes and second;

Cycle plan and once plan can work together.

Items of each plan can be added, modified or deleted. For example, the picture below shows how to add plan items to a day

plan.

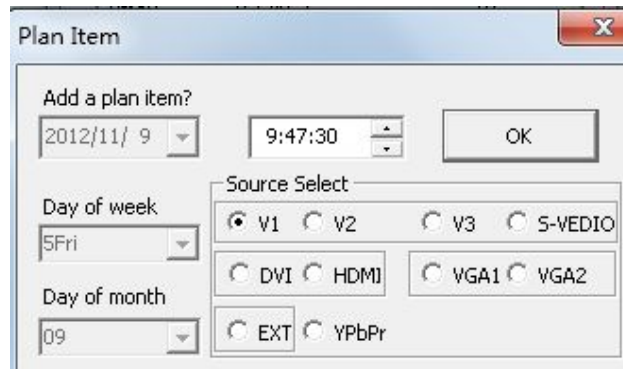

Select the plan already added, and then you can modify or delete it.

3. Fast Mosaic

Multiple units of LVP605 connected in parallel can be used to drive ultra large LED screens. Users can complete input/output parameter configuration of LVP605 through fast mosaic.

In this area, users only need to select a mosaic mode (the layout of LED) and enter the actual pixels of LED driven by each LVP605. The program will automatically calculate the mosaic parameters and save them.

Enter “Fast Mosaic”: after entering the user interface of LVP605,

click , the interface of fast mosaic will appear:

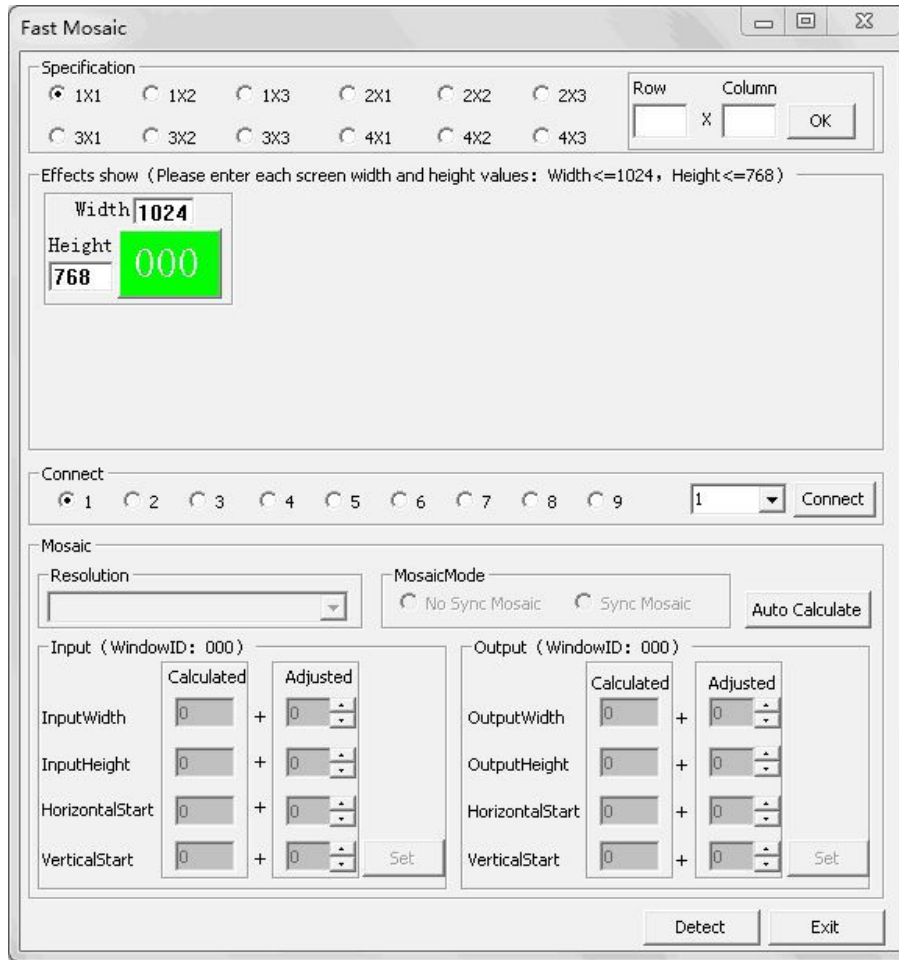
**Remark:**

following conditions must be met for mosaic settings:

1. Settings of brightness, saturation, grayscale and sharpness of each LVP605 should be the same.
2. The output resolution of each LVP605 should be the same; the output resolution should be the same as DVI input resolution.
3. The current selected input source of all units of LVP605 should be DVI and “Mosaic” function is enabled (the indicator of Mosaic is on).

Operating steps of “Fast Mosaic”:

Before performing fast mosaic, make sure that LED screen and all units of LVP605 are working properly, and that each part of the LED screen is able to display a full picture independently. Use the serial port to connect all units of LVP605 or just one of them.

1) Use software to connect LVP605

Select the device ID (same as item no. 21 “Device ID” in user settings) of the first unit, click “Connect”, it will be automatically connected, the software will then read and display its current parameters (e.g.: output resolution).

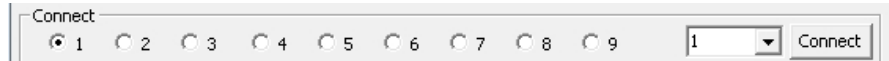

2) Select mosaic mode

Select the current mosaic mode in “Specification” field to decide the layout of LED screen. Users can also manually set the layout. For a LED screen of 3648x2016 pixels, it should use 2x2 mosaic mode.

3) Enter actual parameters of each LED

After selecting proper mosaic mode, the field “Effects show” will display the actual layout of each LED in models, enter the width and height of each LED in turn as shown in the picture below:

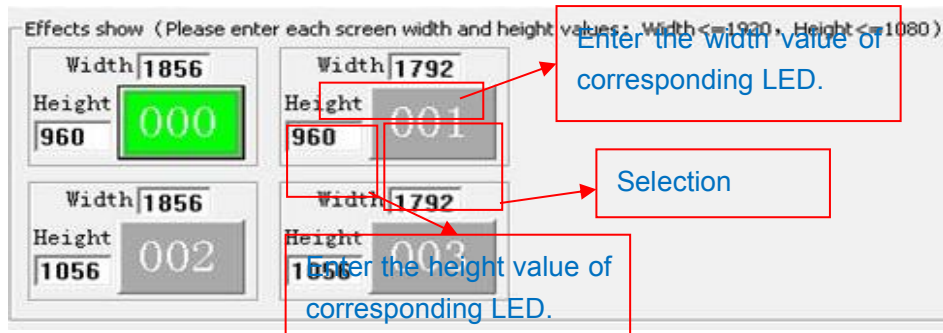

4) Settings of the first unit of LVP605

Click a LED number in the field “Effects show” (we set the first LED as 000) and “Auto calculate”, the software will automatically calculate parameters of the current processor based on the parameters entered in “Effects show”. Select the Mosaic mode desired, and “Sync Mosaic” for the LED, the software will pop up the message “Configuration is successful”. Click “Set” button respectively in input and output field, the software will automatically save the parameters that it worked out in current processor.

Caution:

both input and output parameters of LVP605 must be even, but the results of auto calculation may be odd, if so, it is necessary to set an adjusted value to correct the parameters to be even, and then you can click “Set” to save it.

The screenshot shows the 'Mosaic' configuration window. At the top, there is a 'Resolution' dropdown menu set to '1920x1080@60Hz'. To the right, the 'MosaicMode' section has two radio buttons: 'No Sync Mosaic' (selected) and 'Sync Mosaic'. An 'Auto Calculate' button is located to the right of the radio buttons. Below this, the interface is divided into two main sections: 'Input (WindowID: 000)' and 'Output (WindowID: 000)'. Each section contains a table with 'Calculated' and 'Adjusted' columns. The 'Input' section shows: InputWidth (976), InputHeight (514), HorizontalStart (0), and VerticalStart (0). The 'Output' section shows: OutputWidth (1856), OutputHeight (960), HorizontalStart (0), and VerticalStart (0). Each parameter has a '+' sign between the calculated and adjusted values, and a 'Set' button at the bottom right of each section.

Input (WindowID: 000)		Output (WindowID: 000)			
Parameter	Calculated	Adjusted	Parameter	Calculated	Adjusted
InputWidth	976	0	OutputWidth	1856	0
InputHeight	514	0	OutputHeight	960	0
HorizontalStart	0	0	HorizontalStart	0	0
VerticalStart	0	0	VerticalStart	0	0

5) Parameter configuration of other processors

Connect other processors to be set in turn using RS232 cable, select device ID, select No. of corresponding LED following above step 4), the system automatically calculates the parameters of the processor, then select Mosaic mode. Complete parameters configurations of other processors in this way.

Chapter 8 Notes about models

LVP605D: with a VGA/DVI/HDMI extended input port

LVP605S: with a SDI/HD-SDI extended input port

LVP605: with a VIDEO extended input port

Chapter 9 Copyright info

The copyright of this manual is owned by SHENZHEN VDWALL CO., LTD., unless with prior consent of VDWALL, nobody is permitted to copy or use any part of the information contained herein.

This manual is provided for reference only, VDWALL reserves right to change the product appearance, dimensions and specifications from time to time without notice to users.