

ROBE

RoboSpot Base Station Set

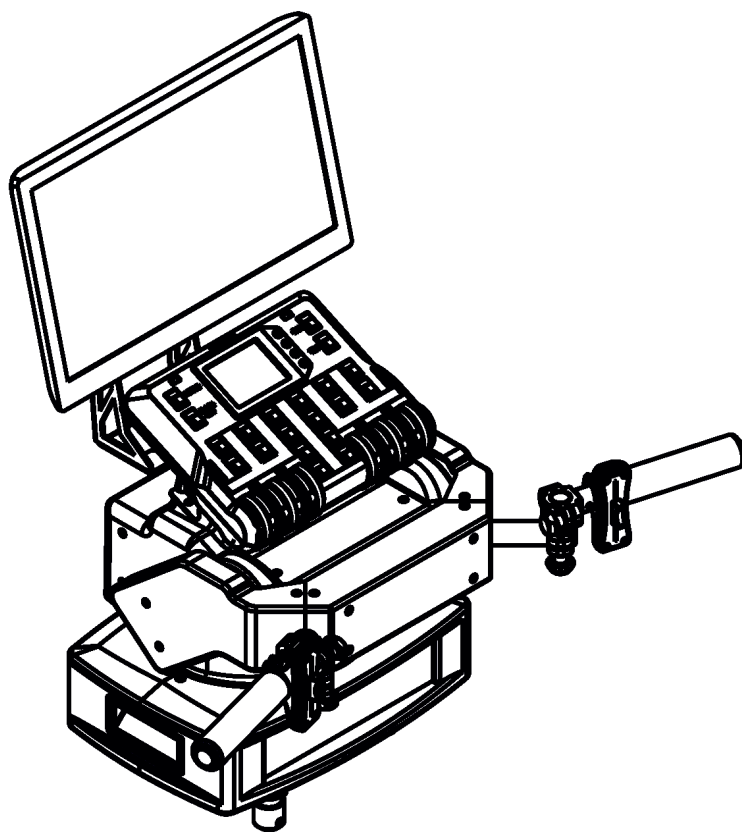

QR code for user manual



USER MANUAL

ROBE® lighting s.r.o. • Czech Republic • www.robe.cz

Version 5.5

RoboSpot Base Station

Table of contents

1. Safety instructions	3
2. Description of the the RoboSpot	4
2.1 RoboSpot	4
2.2 FollowSpot Controller	5
3. Installation	6
3.1 Monitor shield and note holder installation	8
4. RoboSpot connection	9
5. Operation	11
5.1 Functions mapping	11
5.2 Influence of the RoboSpot on the fixture channels	14
5.3 LCD monitor screen	16
5.4 Streaming a camera video	25
5.5 Saving and recalling the FollowSpot controller presets	26
5.6 RoboSpot handles calibration	27
5.7 Multi device control	28
5.8 Dimmer and iris maps	43
5.9 Using Footsies in MDC operation	47
5.10 PosiStage Net	57
5.11 Ethernet based operation	61
6. Control menu	64
6.1 Functions Mapping	65
6.2 Show Library	78
6.3 All Lamps On/Off	80
6.4 Devices Settings	81
6.4 RDM Discovery	81
6.5 DMX In/Out	82
6.6 Product IDs	82
6.8 Software Version	82
6.9 Settings	82
7. Software update	85
8. Error and information messages	85
9. Technical specifications	87
10. Maintenance and cleaning	89
10.1 Replacing the fuse	89
10.2 Replacing the encoder battery	89
10.3 Disposing of the product	89

**FOR YOUR OWN SAFETY, PLEASE READ THIS USER MANUAL CAREFULLY
BEFORE YOU INSTALL THE PRODUCT .**

1. Safety instructions

CAUTION!

**The RoboSpot was designed for indoor use only.
The product is for professional use only, it is not for household use.**

This product has left our premises in absolutely perfect condition. In order to maintain this condition and to ensure a safe operation, it is absolutely necessary for the user to follow the safety instructions and warnings written in this manual.

DANGEROUS VOLTAGE CONSTITUTING A RISK OF ELECTRIC SHOCK IS PRESENT WITHIN THIS UNIT!

Make sure that the available voltage is not higher than stated on the rear panel of the fixture. This fixture should be operated only from the type of power source indicated on the marking label. If you are not sure of the type of power supplied, consult your authorized distributor or local power company.

Always disconnect the fixture from AC power before cleaning, removing or installing a fuse, or any part.

The power plug has to be accessible after installing the fixture. Do not overload wall outlets and extension cords as this can result in fire or electric shock.

Do not allow anything to rest on the power cord. Do not locate this fixture where the cord may be damaged by persons walking on it.

Make sure that the power cord is never crimped or damaged by sharp edges. Check the fixture and the power cord from time to time.

Refer servicing to qualified service personnel.

This fixture falls under protection class I. Therefore this fixture has to be connected to a mains socket outlet with a protective earthing connection.

Do not connect this fixture to a dimmer pack.

If the fixture has been exposed to drastic temperature fluctuation (e.g. after transportation), do not switch it on immediately. The arising condensation water might damage your device. Leave the device switched off until it has reached room temperature.

Do not shake the fixture. Avoid brute force when installing or operating the fixture.

This fixture was designed for indoor use only, do not expose this unit to rain or use near water.

When choosing the installation spot, please make sure that the fixture is not exposed to extreme heat, moisture, dust or entertainment smoke (haze)

Air vents and slots in the fixture are provided for ventilation, to ensure reliable operation of the device and to protect it from overheating.

Operate the fixture only after having familiarized with its functions. Do not permit operation by persons not qualified for operating the fixture. Most damages are the result of unprofessional operation!

Please use the original packaging if the fixture is to be transported.

Please consider that unauthorized modifications on the fixture are forbidden due to safety reasons!

2. Description of the the RoboSpot

2.1 RoboSpot

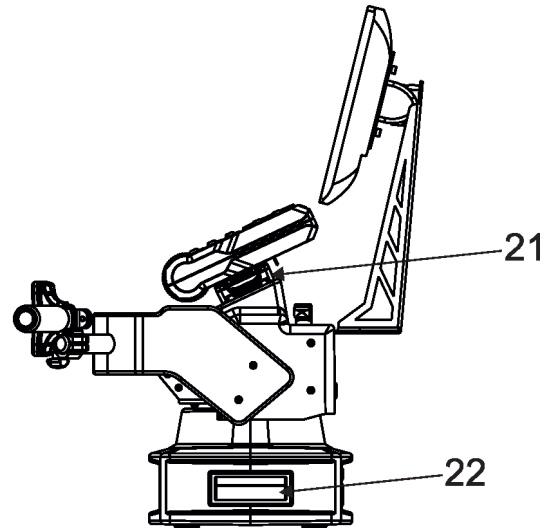
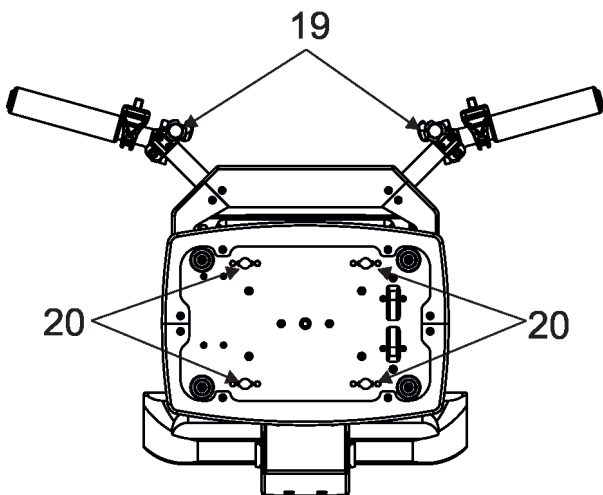
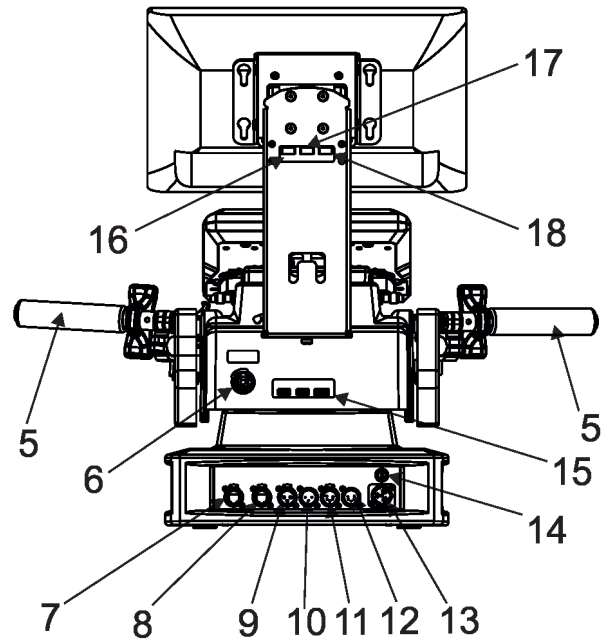
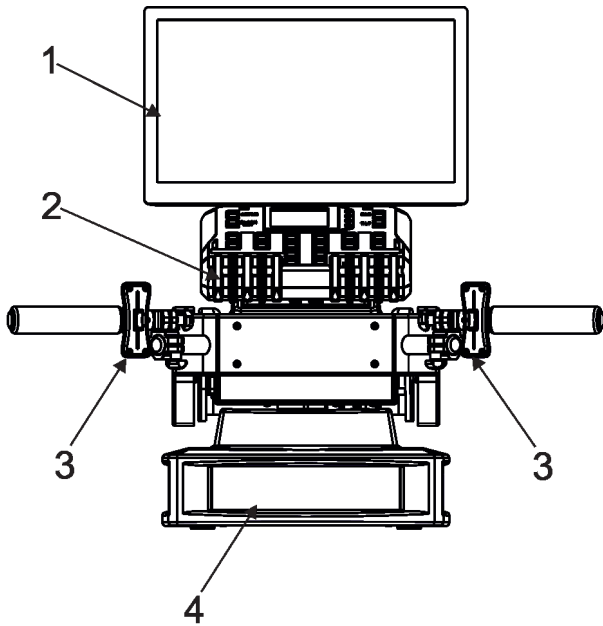

- 1 - Monitor installed on the monitor holder
- 2 - FollowSpot Controller
- 3 - Faders
- 4 - Base
- 5 - Control handlebars
- 6 - Monitor supply
- 7 - Camera IN/Update (RJ45)
- 8 - Ethernet (RJ45)
- 9- (DMX Out (3-pin XLR)
- 10 - (DMX In (3-pin XLR)
- 11- (DMX Out (5-pin XLR)
- 12 - (DMX In (5-pin XLR)
- 13 - Power (Neutrik powerCON TRUE1)
- 14 - Fuse holder
- 15 - HDMI output for monitor + 2 x USB
- 16 - Input for USB lamp (+5V/50mA)

- 17 - USB (50mA)
- 18 - Input for USB lamp (+5V/50mA)
- 19 - Adjusting locks for handles
- 20 - Apertures for 1/4 turn locks
- 21 - Base of the FollowSpot Controller
- 22 - Manipulation handles

2.2 FollowSpot Controller

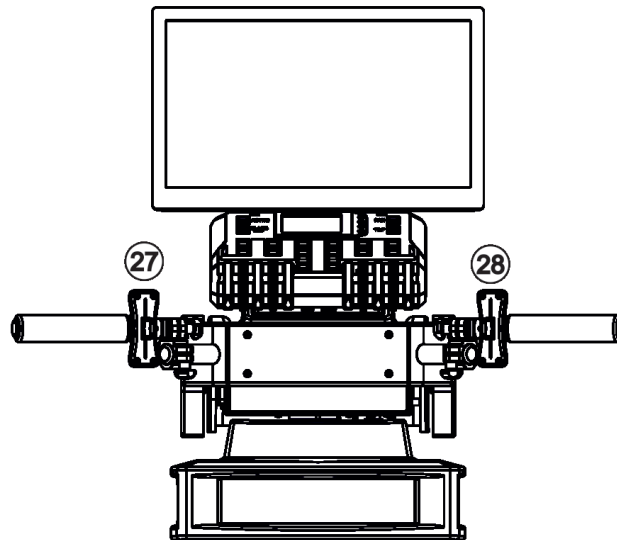
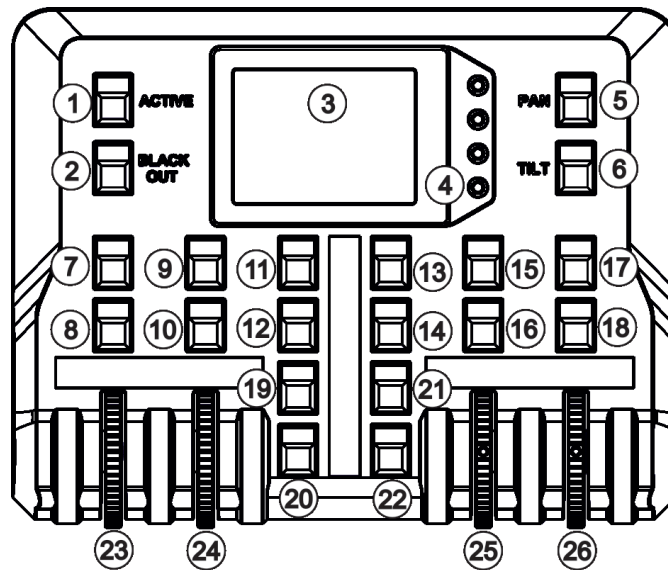

- | | |
|---|---|
| 1 - Activation button (activates the FollowSpot Controller) | 13 - Preset button |
| 2 - BlackOut button | 14 - Preset button |
| 3 - Graphic touch screen | 15 - Preset button |
| 4 - Switch On screen button | 16 - Activation button for jog-wheel (25) |
| 5 - Pan button(enables/disables pan motor) | 17 - Preset button |
| 6 - Tilt button(enables/disables tilt motor) | 18 - Activation button for jog-wheel (26) |
| 7 - Preset button | 19 - Preset button |
| 8 - Activation button for jog-wheel | 20 - Preset button |
| 9 - Preset button | 21 - Preset button |
| 10 - Activation button for jog-wheel (24) | 22 - Preset button |
| 11 - Preset button | 23 - Jog-wheel |
| 12 - Preset button | 24 - Jog-wheel |
| | 25 - Jog-wheel |
| | 26 - Jog-wheel |
| | 27 - left Fader |
| | 28 - Right Fader |

3. Installation

The RoboSpot must be installed by a qualified worker in accordance with all national and local electrical and construction codes and regulations.

Monitor installation

1. Insert the monitor holder (A) into the slot (B) of the RoboSpot and secure it by means of the lock (C). The lock must be fully screwed and reclined. Check the monitor is securely fastened.
2. Connect the power cable of LCD monitor to the socket (D), HDMI cable and two USB cables to sockets (E) in the RoboSpot.

Note: The HDMI connection has to be carried out before connecting the RoboSpot to mains.

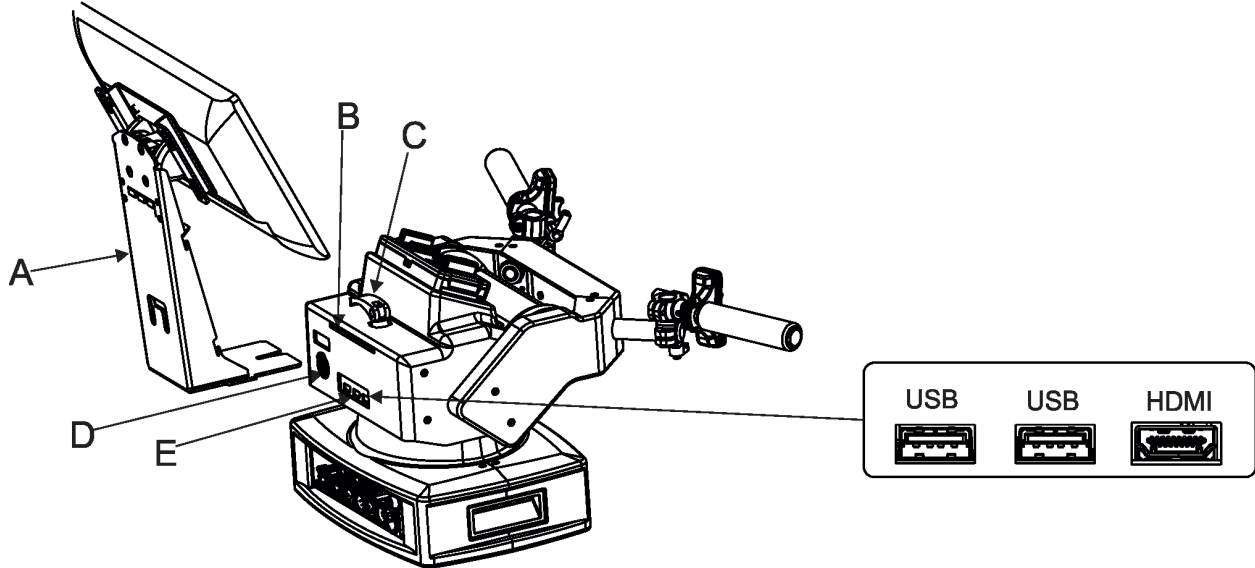

FollowSpot Controller installation

1. Place the FollowSpot Controller (F) on the FollowSpot Controller base (G). Connectors on both parts have to snap each other. Two locks (H) have to be pressed during placing (removing) the FollowSpot Controller (F).
2. If you need to place the RoboSpot on a tripod, you have to install an adaptor with spigot to the tripod.

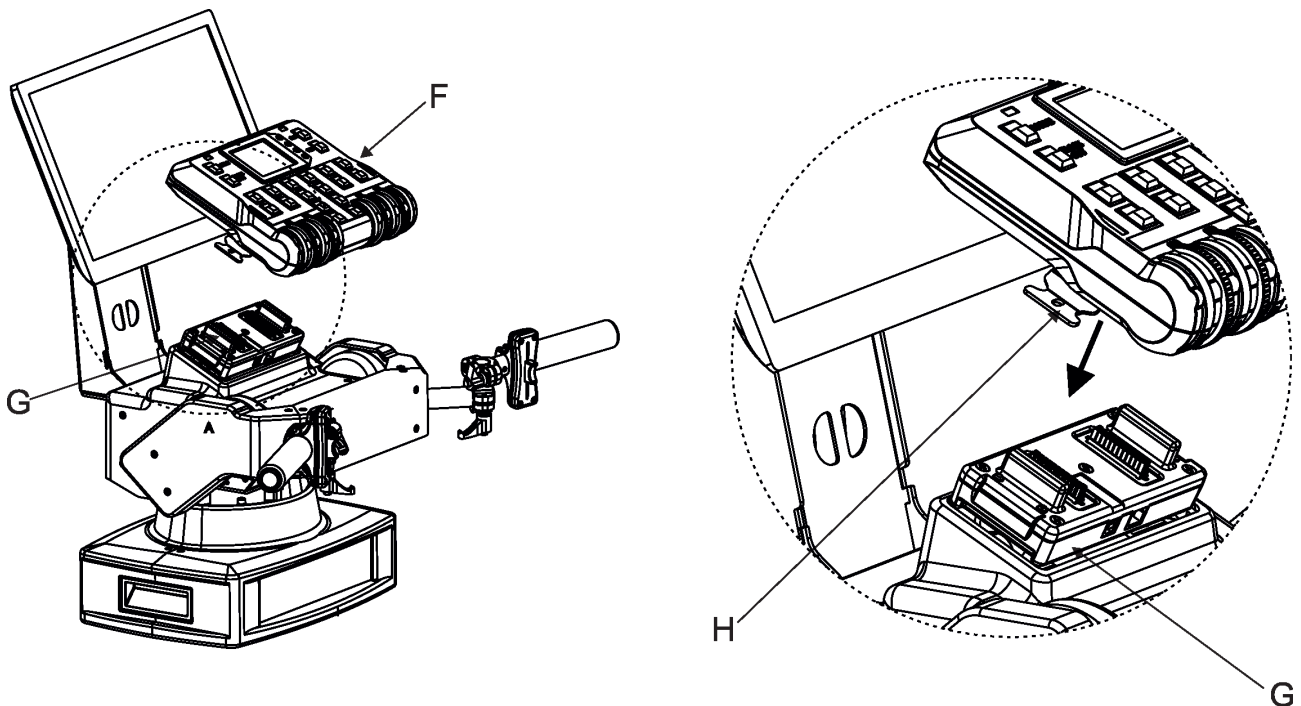

Tripod and adaptor installation

1. Unfold and adjust height of the tripod and distance of legs (8) by means of adjusting locks (4,5,6,7).
The lock (3) has to be in a lower position (as shows arrow on picture below).
2. After inserting the adaptor (1) with spigot (2) to the tripod, the spigot (2) has to be secured by means of the lock (10) and the adaptor (1) by means of the pin (11) which is inserted to the hole (13) of the adaptor (1) as shows arrow on picture below. Position of the pin(11) has to be secured by means of the lock (12).
3. The four quarter -turn locks (9) of the adaptor serve for fastening the RoboSpot on the adaptor. Two workers should install the RoboSpot on the assebled tripod with the adaptor.
Check that all quarter -turn locks (9) are fully tightened before operating the RoboSpot.

Check that all locks (3, 4, 5,6,7, 10,12) are fully tightened before placing the RoboSpot on the tripod with adaptor.

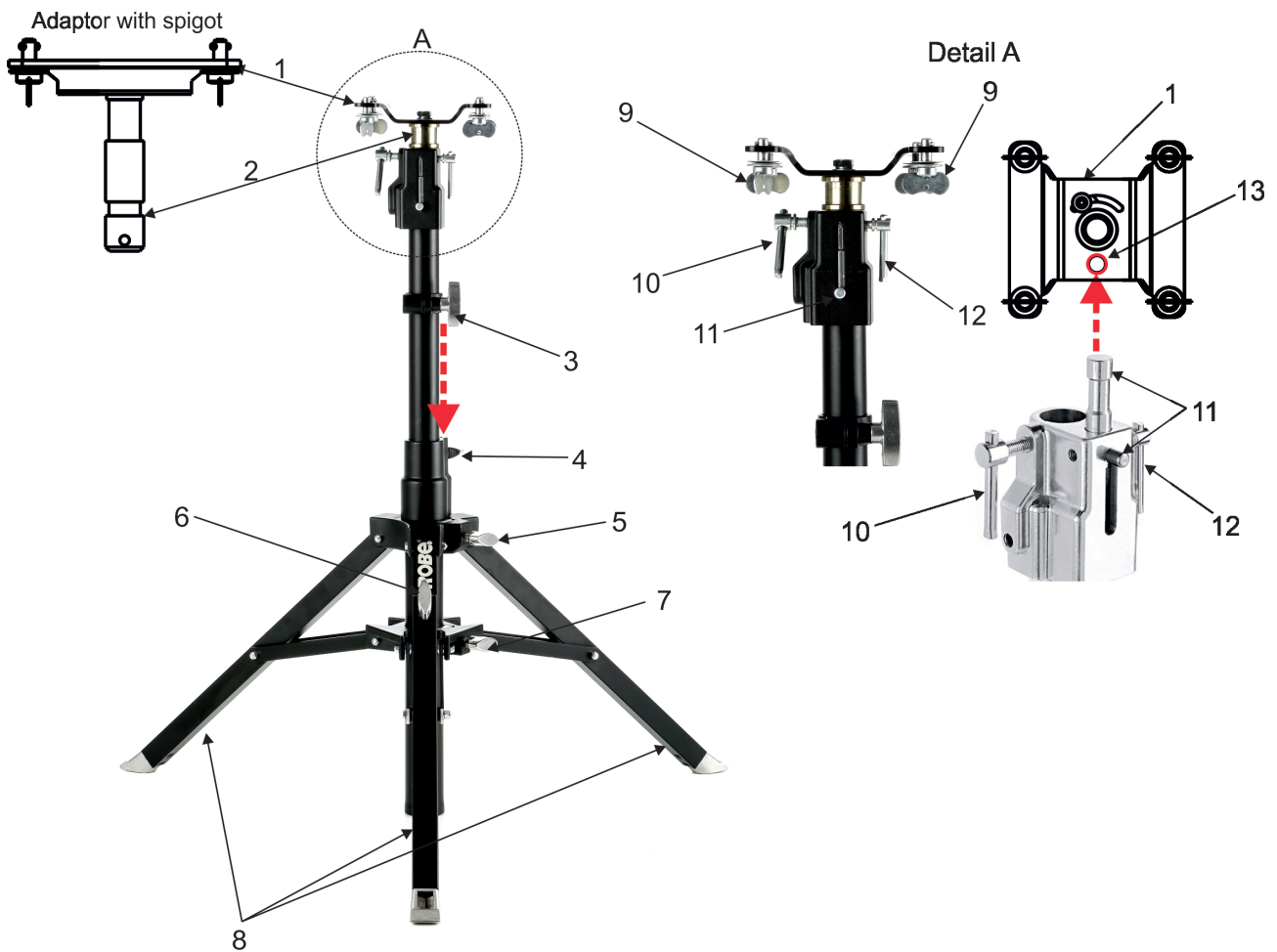

3.1 Monitor shield and note holder installation

1. Place the monitor shield (I) on the monitor holder (A) in this way that pins (J) of the monitor shield snap to apertures (K) in the monitor holder and move the monitor shield down until you reach a stop.

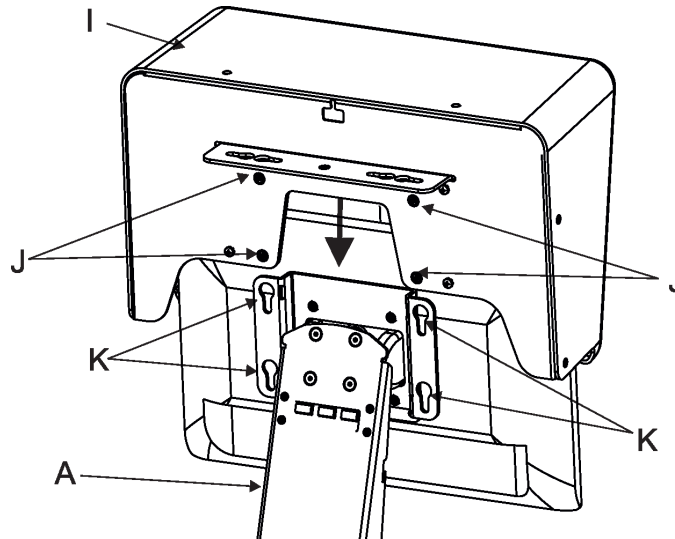

2. Place the note holder (L) on the monitor shield (I) in this way that pins (M) of the arm (P) snap to the apertures (N) of the monitor shield (I) and move the arm (P) to the left until you reach a stop.
3. Secure the note holder to the monitor shield by means of the knob (O).
4. Connect two cables of USB lamps to the sockets marked +5V/50mA on the monitor holder.

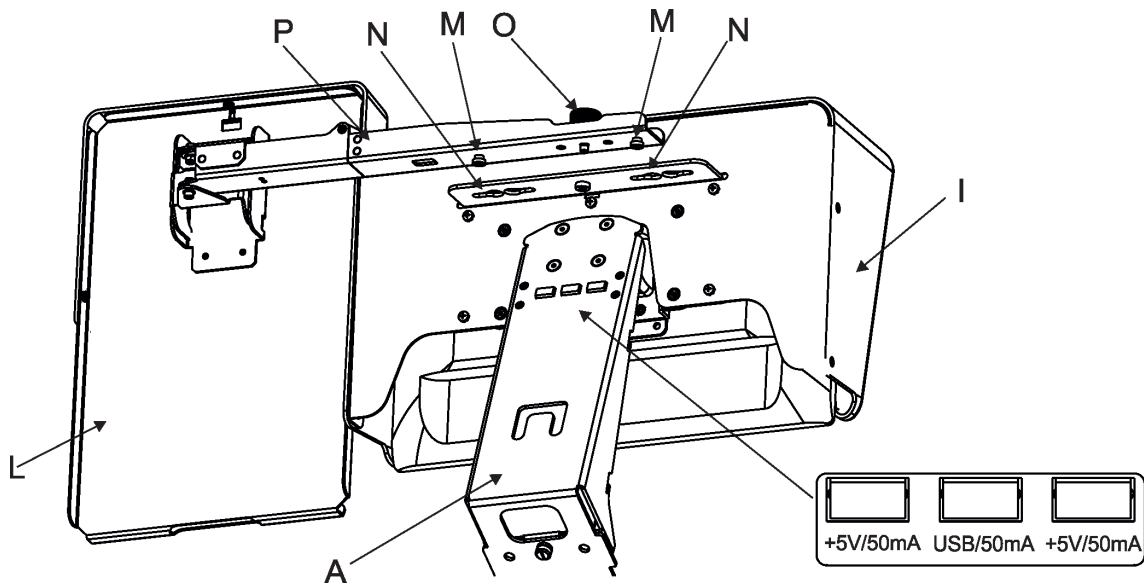

Note. The arm (P) of the note holder (L) can be turned by 180°, this turned position of the arm allows you to install the note holder on the opposite side of the monitor shield.

4. RoboSpot connection

After installing the RoboSpot, connect it with the ROBIN BMFL FollowSpot with camera (or the RoboSpot MotionCamera), with another supported ROBIN fixtures and a control desk.

The RoboSpot has to be connected with a desk by means of Ethernet cable and fixtures intended for the followspot operation have to be connected by means of DMX cable.

You do not need to patch the RoboSpot, but fixtures connected to the RoboSpot have to be patched.

Note: Fixtures connected to the RoboSpot and not supported by the RoboSpot will be ignored by the RoboSpot.

The desk is holding master intensity for the fixtures. You must open up a dimmer on the desk in order to control the light intensity from the RoboSpot. If you for example set a dimmer intensity at 50% on your desk, the RoboSpot operator will have full range of the fader to go from 0-50% of the light intensity.

Example 1. Connection with the ROBIN BMFL FollowSpot with camera

Up to 11 ROBIN BMFL FollowSpots can be connected to the ROBIN BMFL FollowSpot with camera.

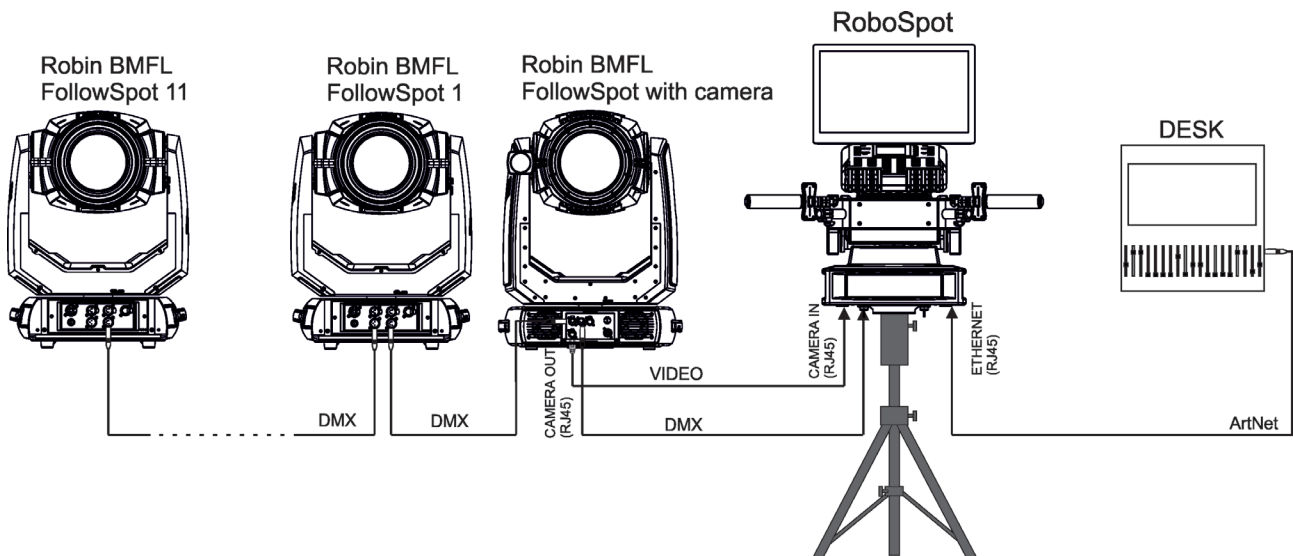

Max. length of ethernet cable between the FollowSpot with camera and the RoboSpot should not exceed 70 m (if some active component is not used).

Example 2. Connection with the RoboSpot MotionCamera

Up to 11 supported ROBIN fixtures can be connected to the RoboSpot MotionCamera. The fixtures should be of the same type.

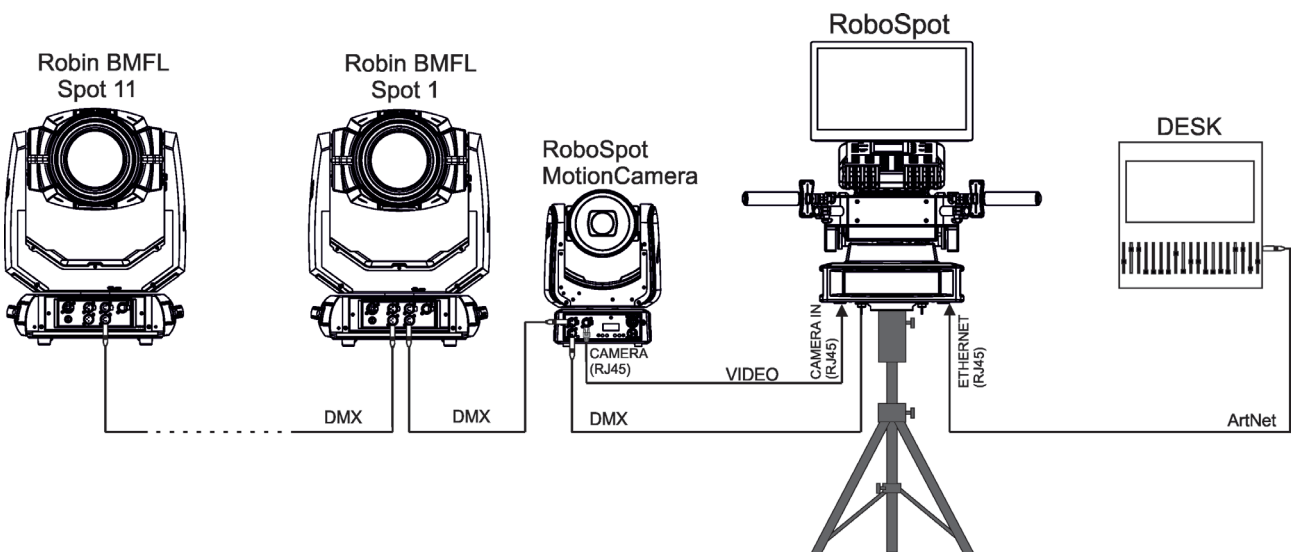

Max. length of ethernet cable between the RoboSpot MotionCamera and the RoboSpot should not exceed 70 m (if some active component is not used).

Note. In case of operating the RoboSpot system in interfered environment, Ethernet switches are recommended in video line (one at the RoboSpot and one at the Robin BMFL FollowSpot or RoboSpot MotionCamera).

In case of using PosiStageNet protocol, you will need to connect an ethernet switch between camera OUT and camera IN of the RoboSpot in order to get position information from the RoboSpot.

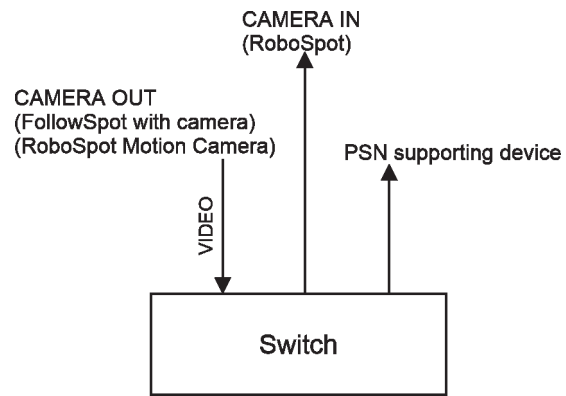

5. Operation

After installing the RoboSpot and connecting it with the ROBIN BMFL FollowSpot (RoboSpot MotionCamera) and another fixtures used for the followspot operation, connect the RoboSpot to mains by means of the enclosed power cord.

Press the button ACTIVE (1) in order to activate the FollowSpot Controller. By pressing the button PAN (5) and TILT (6) you can activate/deactivate of the pan/tilt movement of the ROBIN BMFL FollowSpot (and all connected BMFL fixtures to the RoboSpot).

The button BLACK OUT (2) closes light output of the ROBIN BMFL FollowSpot (and connected fixtures to the RoboSpot).

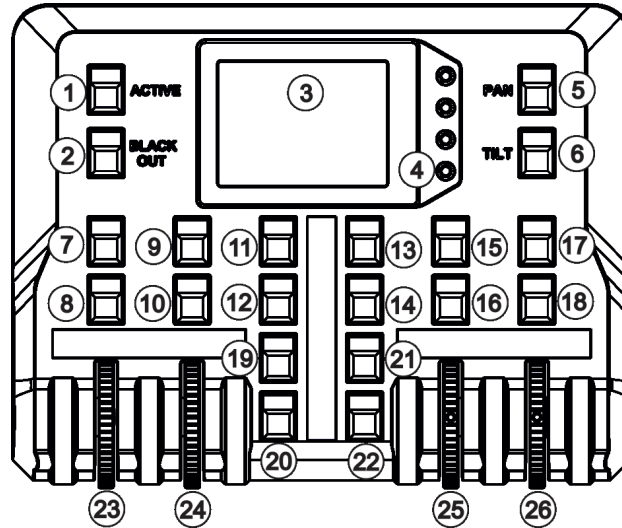

5.1 Functions mapping

After switching the fixture on, touch the Sliders button on the RoboSpot touch screen and use the pan and tilt sliders to set desired position of the ROBIN BMFL FollowSpot's head.

Sliders button



Sensitivity of pan/tilt movement:

High level (most accurate) - green slider

Medium level - yellow slider

Low level - red slider

In order to switch sensitivity of pan or tilt movement to desired level, press and hold the PAN (5) or TILT (6) button until the colour of fader is changed.

It is suitable to set the RoboSpot handlebars to the "middle" position and after that set the pan and tilt position of the moving head by the sliders on the RoboSpot touch screen.

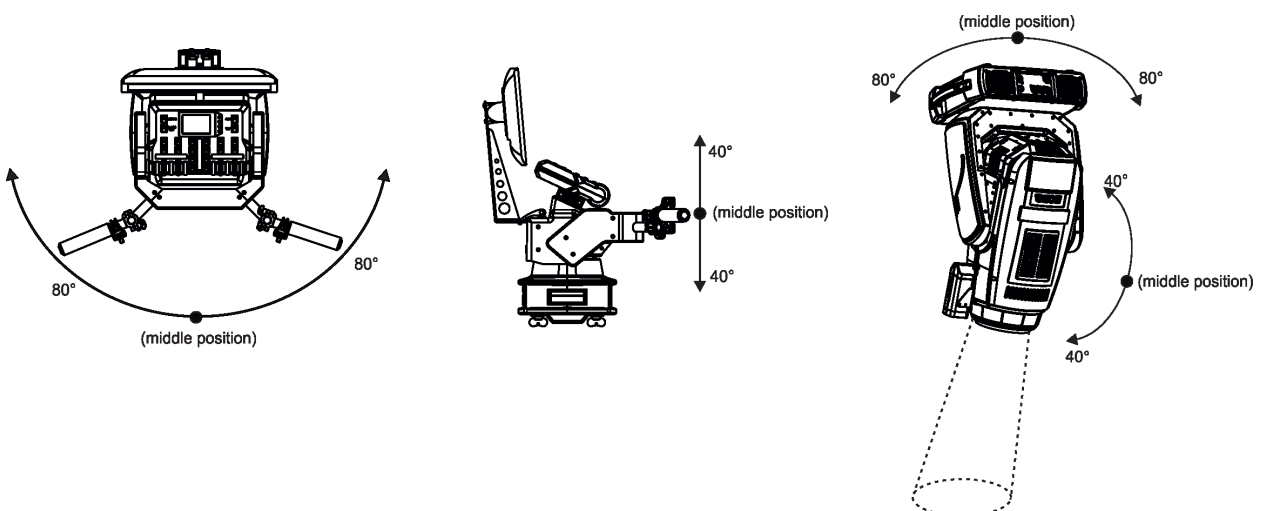

Touch the icon  on the FollowSpot Controller to display the password entering screen:

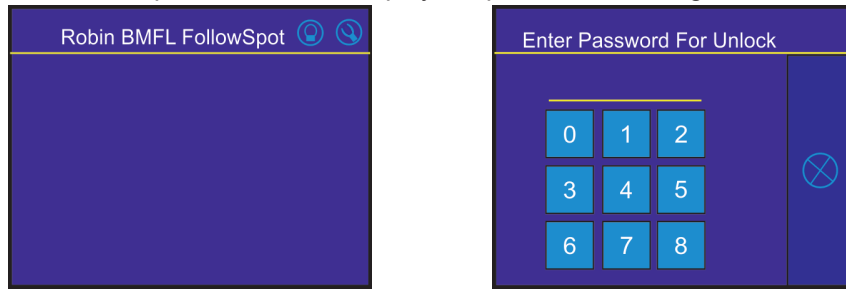

Enter the password (default password is 5242 and also goes for the 15.6" touch screen) to enter the main menu of the FollowSpot Controller. The password prevents unauthorized person from changing setting of the FollowSpot Controller.

Enter the menu "Functions Mapping". The list of available effects will appear:

If the message" Please Activate FollowSpot Controller!" will appear, press the ACTIVE button (1) on the Follow Spot Controller.

Note. If no fixture is connected to the RoboSpot (or DMX cable is disconnected from the RoboSpot), the following message will appear:

" Waiting for devices"

"Long touch here to access setting"

In this case touch the display for cca 4 sec. until the screen with  icon will appear and you will be able to enter the main menu of the controller.

To assign effects to the jog-wheels and faders

1.Touch desired effect. Buttons (8/10/16/18) which activate Jog-wheels (23/24/25/26) and buttons (20/22), which matches faders (27/28) will start to flash.

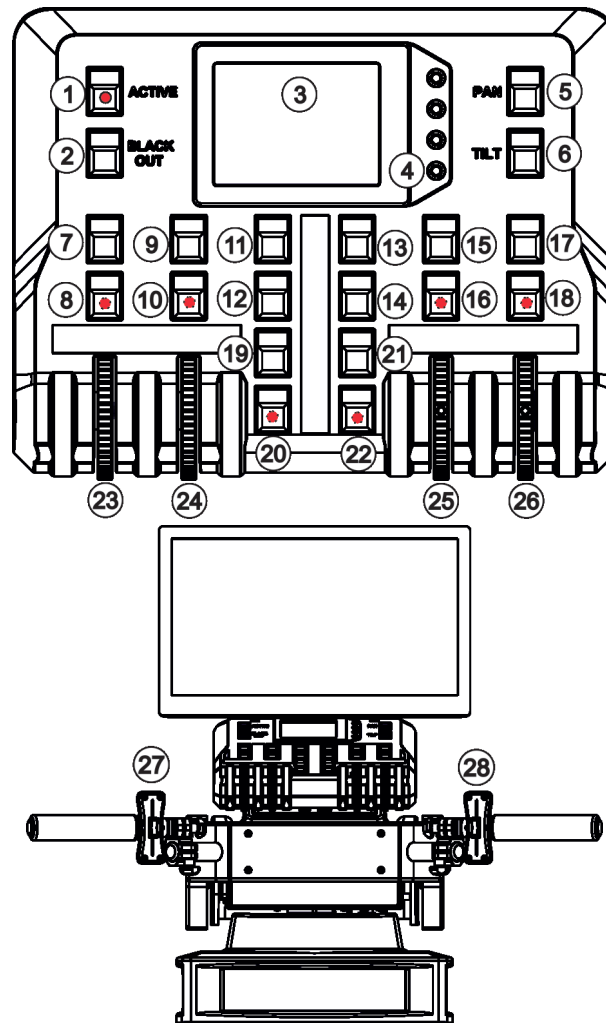

2.Press desired button and selected effect will be assigned to its jog-wheel (fader).

Assigned effect is displayed in a yellow colour, free effects stay in a white colour.

3.Repeat steps 1 and 2 for needed effects.

4. Touch the [cancel] icon and than [back arrow] icon. The screen with effect faders will appear.

E.g.

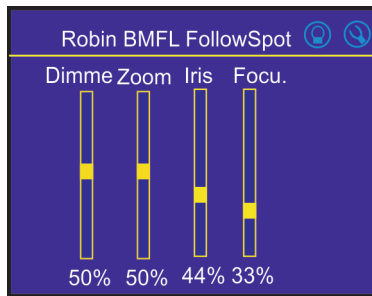

Only effects assigned to the jog-wheels will appear on this screen. Effects assigned to the faders will not be shown.

Sensitivity of the jog-wheels assigned to the effects can be set at three levels: low, medium and high. The levels of the sensitivity are marked in colour on the screen:

low level - red slider
medium level - yellow slider
high level (most accurate)-
green slider

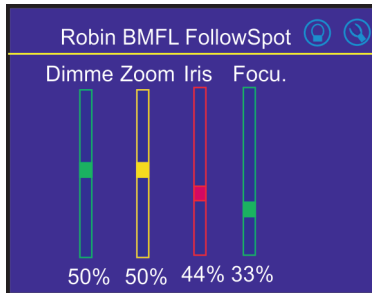

In order to switch an jog-wheel to desired level of sensitivity, press and hold its activating button (8/10/16/18) until the colour of fader is changed.

Effects assigned to the four jog-wheels and two faders on the handlebars have a priority over DMX values coming from a DMX controller.

Functionality of the RoboSpot can be restricted by means of commands on the channel Power/Special Functions (240-255 DMX) of connected fixture.

To control desired effect

1. Use its slider on the screen or press the activating button for its jog-wheel and use this jog-wheel or use a corresponding fader.

The FollowSpot Controller overwrites fixture channels which are mapped to its jog-wheels or faders, excepting a dimmer. The dimmer value is a combination of value coming from DMX console and a value on the FollowSpot Controller (e.g. DMX console sends 180 DMX, jog-wheels shows 50%, real DMX value coming to fixture is 90 DMX).

In case that the DMX console does not send DMX data, the FollowSpot Controller allows full range (0-255 DMX) of dimmer control.

To release an effect from the jog-wheel (fader)

1. Touch desired effect from the list of effects in the menu "Functions Mapping".

2. Touch the option "Unlink".

3. The effect will be displayed in a white colour.

The item "All" allows you to release all assigned effects at one go.

5.2 Influence of the RoboSpot on the fixture channels

The general rule (with a few exceptions described in the table below) is the RoboSpot controls mapped channels (functions) on jog-wheels or faders in range which allows the FollowSpot Controller (see the chapter 6.1 Menu Functions Mapping).

Non-mapped channels (functions) are subject to full control of a desk except:

Colour channels (CMY+CTO and RGB(W)+CTO) if Colour Buttons are active.

Zoom/focus in Multi Device Control if the function Auto Zoom/Foc. is on.

Pan/tilt.

Pan/tilt speed (use the Track slider in the Slider menu on the screen to set desired pan/tilt speed).

Behaviour of the shutter channel:

Closed shutter on the desk closes light output on a fixture connected to the RoboSpot.

Open shutter on the desk - light output of the connected fixture can be closed by the BlackOut button on the FollowSpot controller.

Table of behaviour of some mapped channels (functions) on the RoboSpot (if the RoboSpot control is fully enabled-see the following page).

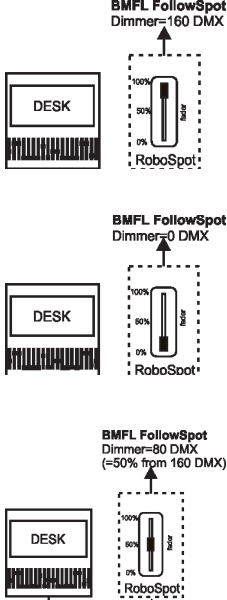
Mapped channel (function)	Behaviour of channel		Comment
	Single Device Control	Multi Device Control (MDC)	
Dimmer	<p>Jog-wheel or fader* of the RoboSpot controls a light intensity from 0% to the value set at desk.</p> <p>Examples:</p>  <p>To get max. light intensity, set desk dimmer =100% and the RoboSpot fader=100%.</p>	The same as at Single Device Control	Exception: the RoboSpot takes full control over dimmer during the process "Setup MDC" (menu "Multi. Dev. Control").
Zoom, Focus	Jog-wheels or faders* allow full control in range of 0-100%.	<p>1. Auto Zoom/Foc.= Off The same as at Single Device Control.</p> <p>2. Auto Zoom/Foc.= On MDC takes control over zoom and focus regardless of it if they are mapped on jog-wheels or faders or not. <u>If zoom and focus are mapped</u> - offsets set on jog-wheels or faders are added to automatically calculated values. <u>If zoom and focus are not mapped</u> - automatically calculated values are used (offsets on jog-wheels or faders are set to 0).</p>	Auto Zoom/Foc. is the function in the menu "Multi. Dev. Control".

* depends on functions mapping to the control elements of the RoboSpot.

The Power/Special Functions channel of supported fixtures offers three control modes of the RoboSpot. You can use a full control of the RoboSpot, fully disable the RoboSpot or disable the RoboSpot excepting two faders and manual pan/tilt.

Example for the Robin BMFL FollowSpot:

Channel Power/Special Functions (channel 6)	
DMX values	Function
240-244	RoboSpot enabled
245-249	RoboSpot disabled - except handle faders and pan/tilt
250-255	RoboSpot fully disabled

Zoom and focus of fixtures used in the MDC (Multi Device Control) are influenced by setting of the channel Power/Special Functions, mapping of zoom/focus on the FollowSpot Controller and setting of MDC.

Influence of the settings describes the following table:

Channel Power/Special Functions	FollowSpot Controller	menu MDC (Multi Device Control)	Behaviour of Zoom/Focus
RoboSpot Enabled	Zoom/Focus are not mapped	Auto Zoom/Foc.= On	MDC takes control over zoom and focus (offset set to 50%)
		Auto Zoom/Foc.= Off	Zoom and focus are controlled by a desk
	Zoom/Focus are mapped	Auto Zoom/Foc.= On	MDC takes control over zoom and focus by Jog-wheels or faders (offset)
		Auto Zoom/Foc.= Off	Jog-wheels or faders allow control of zoom and focus (real values)
RoboSpot disabled (except handle faders and manual pan/tilt)	Zoom/Focus are not mapped	Auto Zoom/Foc.= On	MDC takes control over zoom and focus (offset set to 50%)
		Auto Zoom/Foc.= Off	Zoom and focus are controlled by a desk
	Zoom/Focus are mapped on Jog-wheels	Auto Zoom/Foc.= On	MDC takes control over zoom and focus (offset set to 50%)
		Auto Zoom/Foc.= Off	Zoom and focus are controlled by a desk
	Zoom/Focus are mapped on faders	Auto Zoom/Foc.= On	MDC takes control over zoom and focus by faders (offset)
		Auto Zoom/Foc.= Off	Faders allow control of zoom and focus (real values)
RoboSpot fully disabled	Zoom/Focus are not mapped	Auto Zoom/Foc.= On	Zoom and focus are controlled by a desk
		Auto Zoom/Foc.= Off	
	Zoom/Focus are mapped	Auto Zoom/Foc.= On	
		Auto Zoom/Foc.= Off	

5.3 LCD monitor screen

The RoboSpot is equipped with the 15.6" (10-point) touch screen with max. resolution 1366 x 768. After switching the RoboSpot and the ROBIN BMFL FollowSpot with camera (or the RoboSpot MotionCamera) on, image scanned by the camera is displayed on the LCD screen.

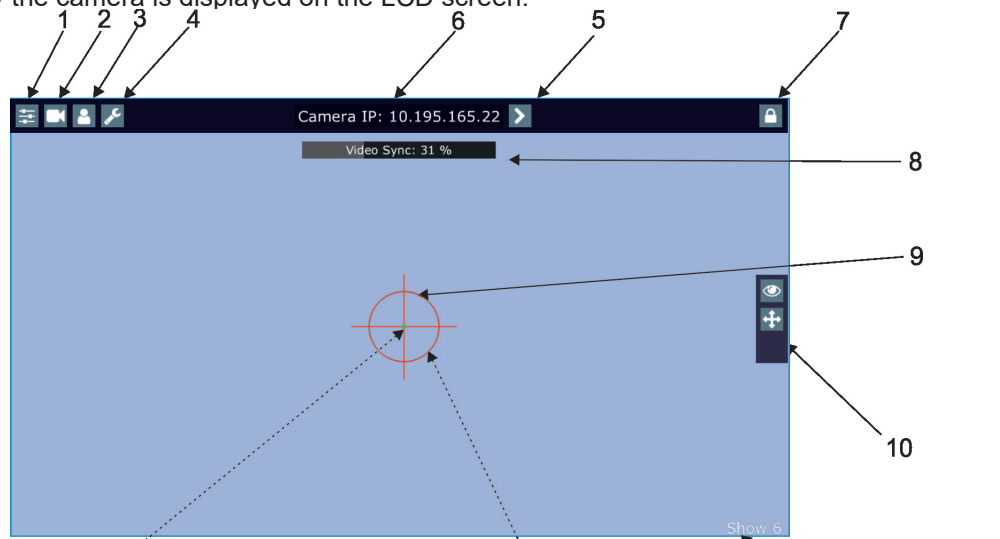

Touch the red cross and move the position circle to desired position on the screen.

Touch the edge of the position circle and move it in/out to decrease/increase the size of the circle

Current scene

- 1- Slider button
- 2- Camera button
- 3- User button
- 4- Service button
- 5 - Camera selection buttons

- 6- IP address of selected camera*
- 7- Screen lock***
- 8- Video synchronization box**
- 9 - Position circle (red)
- 10 - Action toolbar

To centre the position circle on the screen, touch the red cross it until the following dialog box will appear:

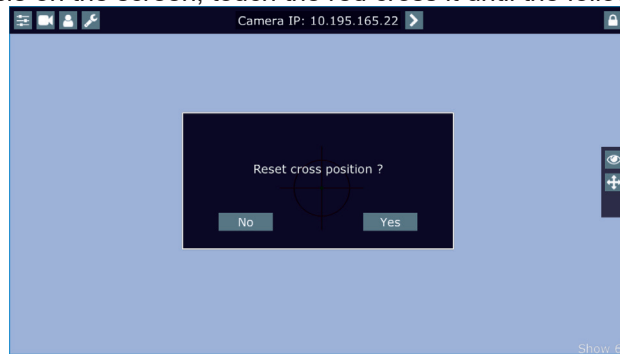

Select option Yes and the position circle will be placed to the centre of the screen.

*You can change the name of selected camera. To rename selected camera, touch for two seconds the camera name (e.g. Camera IP: 10.195.164.171).

The software touch keyboard will appear. Use the keyboard to type a new name of camera (e.g. Camera 1). Touch ENT to save the new name of the camera. The new name is saved into camera (in case that you will use other Robospot, the new camera name will be reloaded)

Touch the key X to close the keyboard.

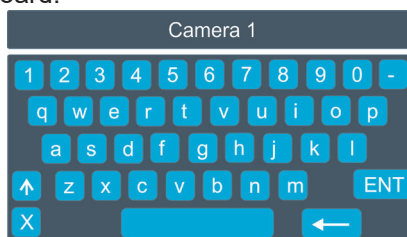

**When you switching between cameras, a box with video synchronization status is displayed. This box shows a delay between the camera and the screen. The value 0% means max. delay, 100% is without delay (and this box will disappear from the screen after reaching 100%).

*** To lock the screen, touch the button . The following options will appear on the screen:

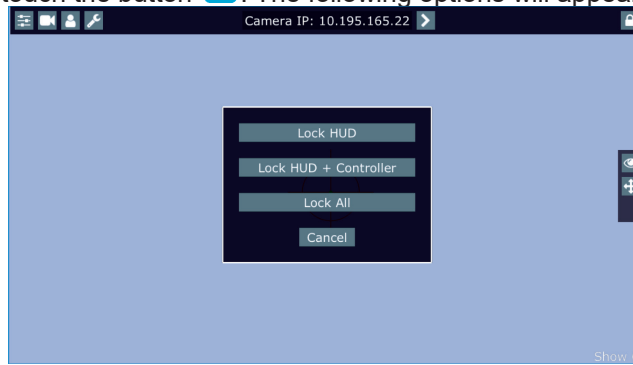

Lock HUD - this option locks the LCD monitor screen. Positions buttons and pan/tilt movement by means of the control handlebars are available.

Lock HUD + Controller - this option locks the LCD monitor screen and the FollowSpot Controller display. The FollowSpot Controller presets and Jog-wheels are available (Jog-wheels have to be activated before locking the FollowSpot Controller display). Positions buttons and pan/tilt movement by means of the control handlebars are also available.

Lock ALL - this option locks all RoboSpot system

To unlock the screen, touch the button  and the software touch keyboard will appear. Type a correct password (the password is the same as the password for the FollowSpot Controller, default password is 5242) and confirm it by touching the key ENT. Touch the key X to close the keyboard.

Note: the message "Not correct camera settings! Reset camera settings?" informs you that the RoboSpot software and the camera settings are not accordance.

Use the option "Yes" to set correct camera settings.

The option "Yes" has the same effect as the option "Factory reset " in the Camera button menu.

The message "Last used camera not present. Wait for camera?" informs you that the RoboSpot cannot find last used camera. If you select Yes, the RoboSpot will still search for last used camera, if you select No, the RoboSpot will use another founded camera.

After switching the ROBIN BMFL FollowSpot lamp on and adjusting its beam (zoom, focus, dimmer...), aim the beam to desired position by means of the pan/tilt handles.



Touch and move the position circle on the beam image and set its size in order to match to beam image. Now, when you move with the control handles, both beam image and position circle on the screen will move synchronously. In case that the light output from the fixture is closed, you know the position of the light beam by means of the position circle.

Note: if you change a camera zoom, you have to move and adjust the position circle on the beam image again.

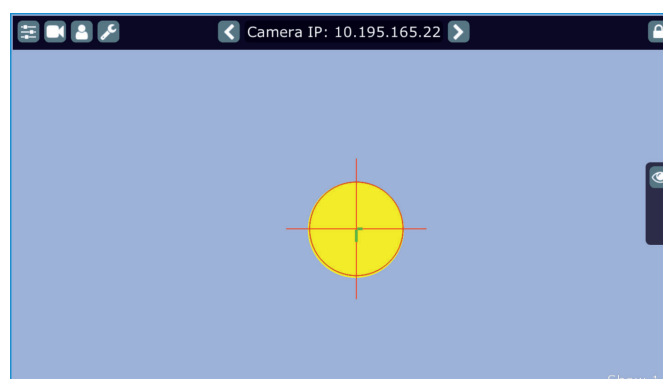

The green lines in the position circle give pan and tilt position of the control handles.
The green point in the centre of the position circle signals the middle position of the control handles.

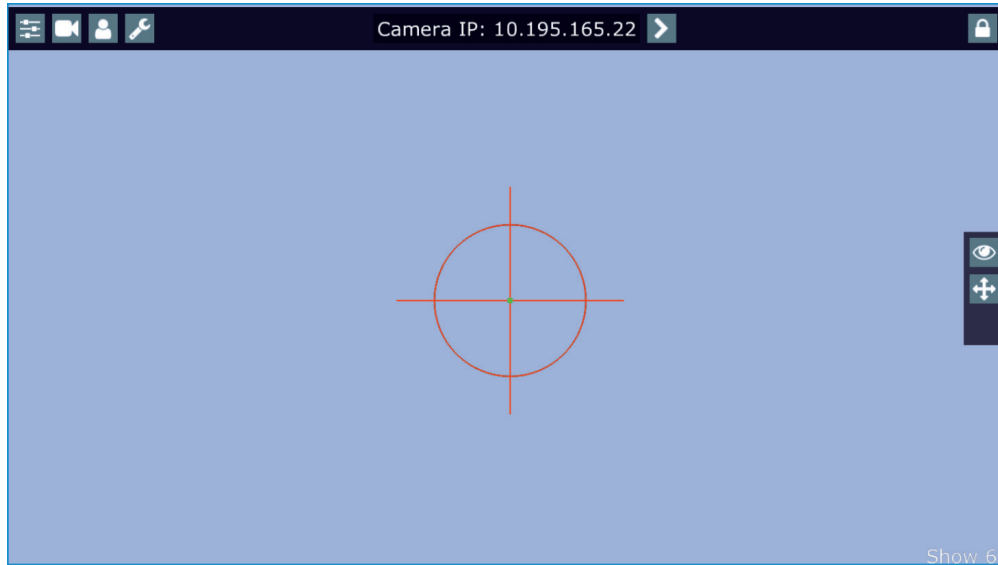

If you move with control handles, the distance between the green lines and the red circle will give available range of pan and tilt movement of the control handles. The red circle poses a "limit" of pan/tilt movement.

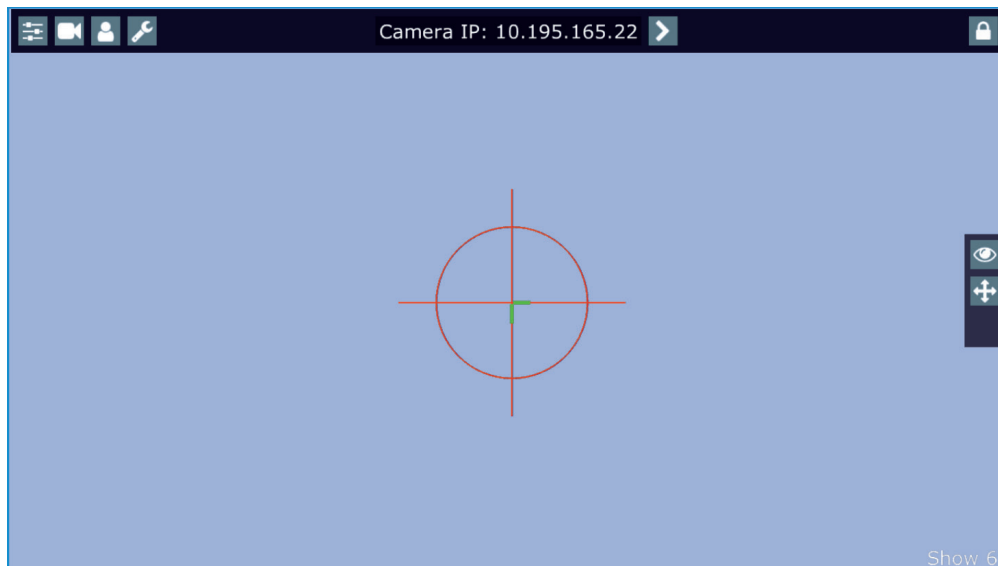

Note.
If the pan/tilt control handles requires recalibration, the following screen will appear.

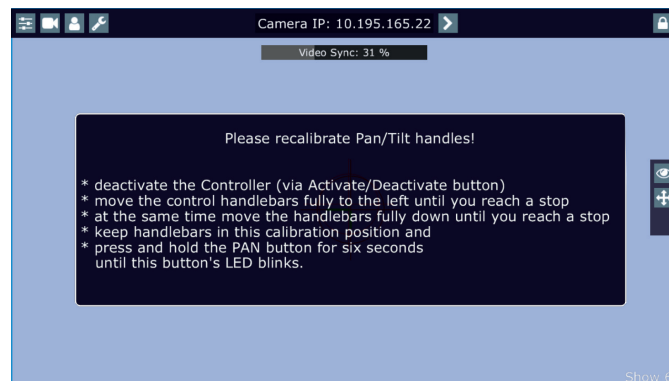

In this case please do a calibration of pan/tilt handles as described in the article "5.5 RoboSpot handles calibration".

Sliders menu



Zoom slider- use it to change a zoom of currently selected camera. A sensitivity of a camera zoom can be set in three levels: low (green slider), medium (yellow slider) and high (red slider).

To change the sensitivity level of the camera zoom, the camera zoom has to be assigned to some jog-wheel of the FollowSpot Controller, please see the chapter "Functions mapping" how to change sensitivity level of a slider. After changing of zoom size, picture is automatically focused.

Pan/Tilt sliders - use them to move a moving head to the desired position. A Sensitivity of pan/tilt movement can be set in three levels : low (green slider), medium (yellow slider) and high (red slider).

In order to switch the sensitivity of pan or tilt movement to desired level, press and hold the PAN (5) or TILT (6) button until the colour of fader is changed.

Track slider- use it to set desired level of speed of pan/tilt movement. Each level of the track slider responds to the DMX value of the Pan/Tilt speed channel in DMX chart of BMFL fixture:

Track level	DMX value on the Pan/Tilt speed channel
Smooth	0
Fast	1
Medium	10
Slow	20

Camera menu



Rotate Picture- use this item to rotate a picture on the touch screen 180 degrees from current orientation.

Refocus- use this item to focus an image on the screen (Focus of the camera is set to the "One shot focus " mode which means that picture is focused automatically after zoom change and the item Refocus allows to focus the image when the zoom is without change.

Exposure- the menu item allows you to choose a level (Low, Medium, High) of light intensity in the position circle on the screen to see hidden objects from reason of high light intensity in the position circle on the screen. The item Auto switches the function off.

DayNight mode- the menu item allows you to choose desired colour mode of the camera:

Auto - Normally, video output is set to Color but to B&W under low luminance.

Color - The video output is always in color.

B&W - The video output is always in black and white.

Reconnect- the item disconnects and again connects active camera to the RoboSpot. Use the item in case that behaviour of the camera is not correct (e.g. long response time).

Factory Reset- use this item to set a camera to the current setting.

All items stated above relate to the selected camera in the menu bar.

Every camera holds information about position of the position circle, its size and picture rotation.

User menu



Blackout Display - use the item to darken the screen. To active the screen, touch it.

Target Cross - use the item to switch on/off the red position circle.

Trace Cursor - if the function is on, a blue circle will appear during (behind a red position circle) which gives a target position of the position circle (beam image) during its movement.

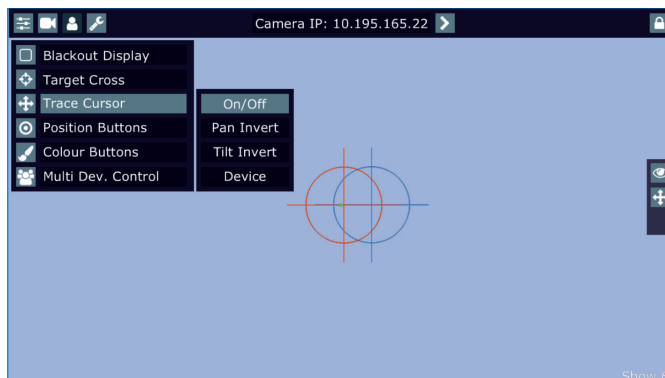

Pan Invert - the item inverts a pan movement

Tilt Invert - the item inverts a tilt movement

Device - the menu allows you to select a device with camera. Correct device has to be chosen if the "Trace Cursor" function is to work correctly.

MotionCamera - select the item if you use the RoboSpot Motion Camera.

BMFL Follow Spot - select the item if you use the Robin BMFL FollowSpot with camera.

Position Buttons - if the function is on, the "+" button will appear at the bottom of the screen. Move the position

circle to desired position and press the "+" button. Button no.1 will appear at the bottom of the screen and the button no.1 is assigned to this position of the position circle (if item " Show in scene is active, button no.1 is displayed in the position circle on the screen). You can assign up to 9 buttons to different positions of the position circle on the screen.

If you touch a position button, the position circle will move to the position of this position button. Last activated position button is highlighted.

Example (option "Show in Scene" is active):



Show in Scene - the item allows you to show positions of the position buttons on the screen.

In the position button are saved values of the following items: pan position, tilt position, pan/tilt sensitivity, zoom sensitivity, MDC height, speed, zoom, focus, camera zoom, camera rotation, cross position, cross size. To edit, rename or remove the position button from the screen, touch desired position button until the message "Edit, Rename or Delete pos.button "3"?" appears on the screen and select desired option.

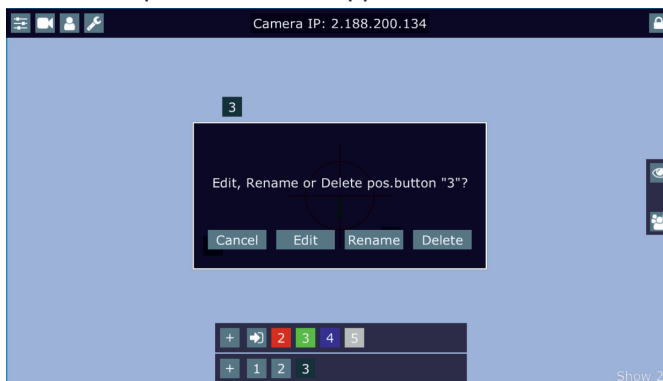

If you select the option "Edit", the following screen with attributes will appear.



Now you can uncheck(check) attributes which you wish to be active in the position point.

Some menu attributes include more functions:

"Position" = pan + tilt + MDC height

"Camera Zoom/Rotation" = camera zoom + camera rotation

"Cross" = size + position

"Sensitivities" = pan sensitivity + tilt sensitivity + zoom sensitivity

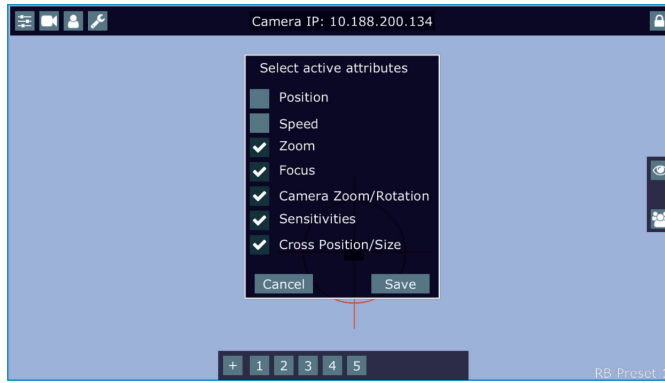

If you select the option "Rename", the following keyboard will appear on the screen and you can type a new name (max. 3 characters) for the position point.



Colour Buttons - the function allows you to change colour on used fixtures together. The function controls colour channels (Red/Green/Blue/White/CTO channels at LEDs fixtures and Cyan/Magenta/Yellow channels at lamp fixtures). When choosing desired colour, corresponding channels are taken over from a desk to the Robospot.

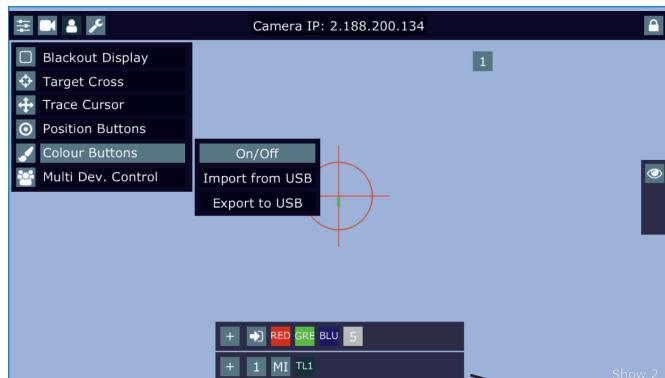

Colour bar

Touch the button + and the following screen will appear.

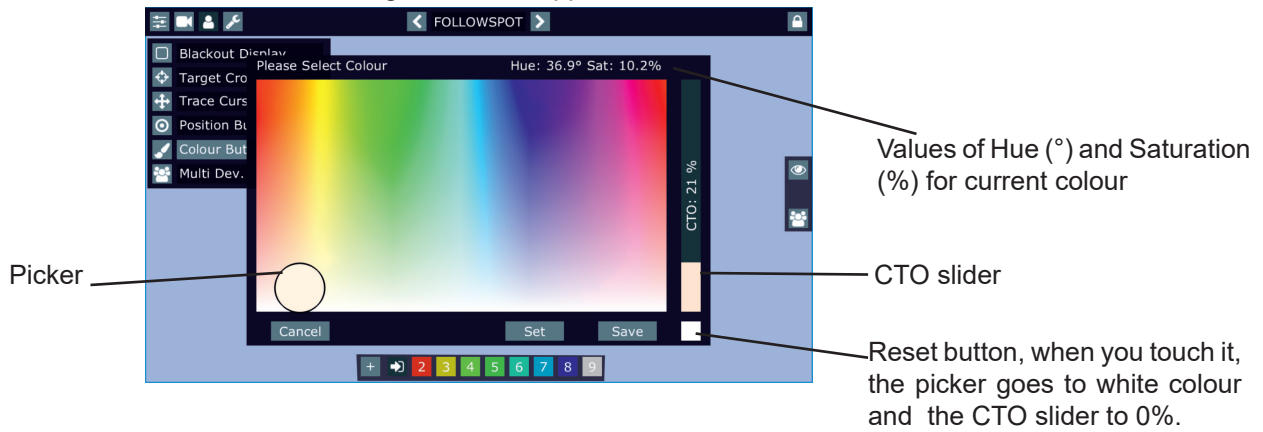

Use the circular picker to choose a desired colour. The chosen colour can be "send" to fixtures by pressing the button Set or saved to the colour bar at the bottom of the screen by pressing the button Save. Up to 8 colour buttons can be saved to the colour bar. Only RGB or CMY colours can be controlled via the circular picker. Desired colour can be activated by touching its button in the colour bar.

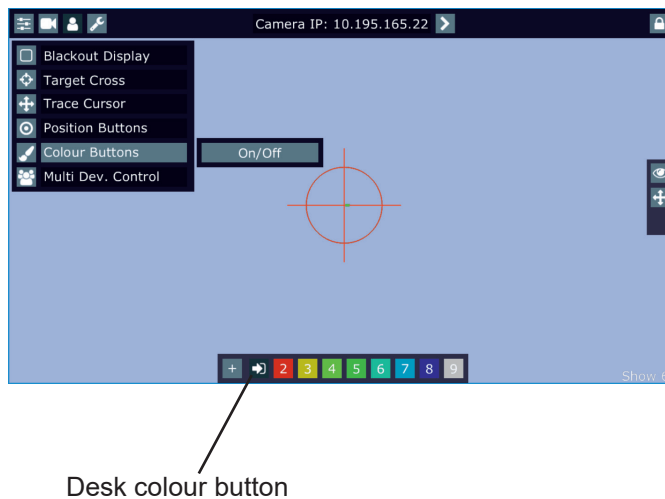

The Desk Colour button passes colour channels on to the control from a desk.

If you want to delete or rename a colour button, touch and hold a finger on the colour button until the following message appears "Rename or Delete colour button X?".

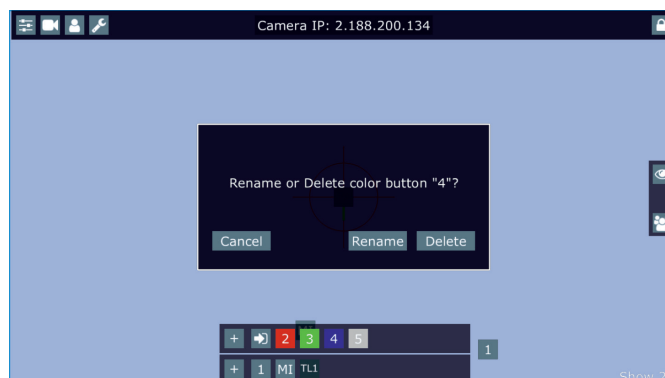

When you choosing option "Rename", the virtual keyboard will appear and you can type name of colour (max. 3 characters).

The option "Export to USB" allows you to save colour buttons to the file on the USB flash drive. To export colour buttons.

1. Connect a USB flash drive to the USB port marked USB 50mA.
2. Select option "Export to USB".
3. The virtual keyboard will appear on the screen. Type the name of file (e.g. colors1) and confirm it by the key ENT. The colours file on the USB flash drive will have extension rscb (e.g. colors1.rscb).

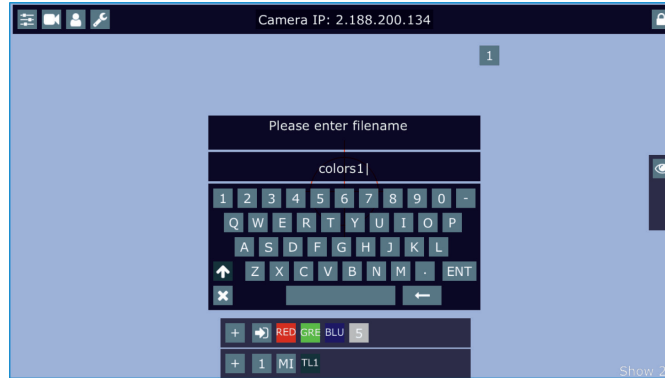

The option "Import from USB" allows you to import colour buttons from the file on the USB flash drive. To import colour buttons.

1. Connect a USB flash drive to the USB port marked USB 50mA.
2. Select option "import from USB".
3. Select a colour buttons file (e.g. color2.rscb) which you want to load from the USB flash drive and touch the button Import.

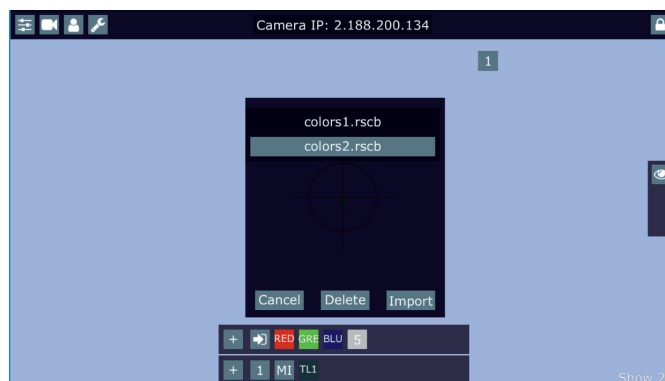

This option also allows you to delete colour buttons file from the USB flash drive.

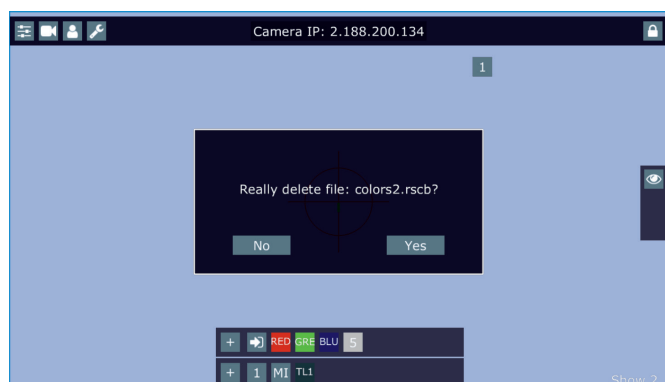

Multi Dev.Control- the menu serves for activating and setting control of fixtures in the multi device operation. For more information please see the chapter Multi device control.

Service menu

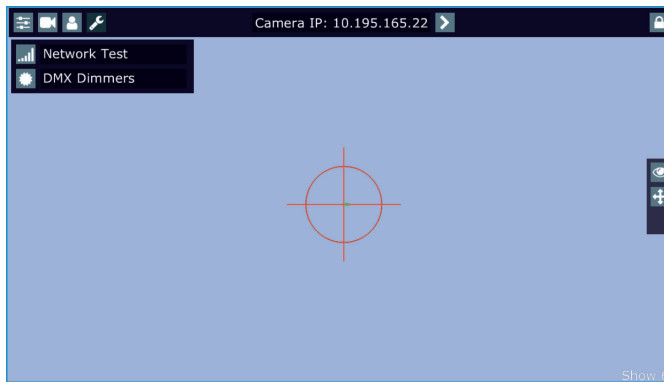

Network Test - the item runs a connection test between a camera and the RoboSpot. During the test, do not touch any buttons on the FollowSpot controller.

DMX Dimmers - the item shows value of dimmer for each fixture (in %). This dimmer value of the corresponding fixture is calculated from a DMX value of dimmer sent from a desk to the fixture and a position of fader or Jog-wheel (depends on fixture mapping).

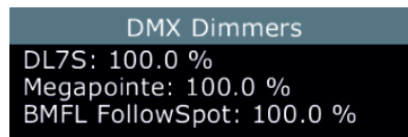

E.g. DMX value for dimmer sent from the desk to a fixture is 120, by means of the fader (Jog-wheel) this value can be changed from 0 DMX to 120 DMX.

5.4 Streaming a camera video

If you wish to stream a camera video over computer network, use a rtsp stream supported media player (e.g. VLC media player, SMPlayer,...) running on your computer and type the following to your media player:

```
rtsp://IP address of camera/profile2/media.smp
```

example: `rtsp://10.195.165.223/profile2/media.smp`

Important: max. number of VLC clients for one camera is 1.

5.5 Saving and recalling the FollowSpot controller presets

The FollowSpot Controller offers you to save up to 12 presets.

To save the FollowSpot controller preset

1. Press and hold one of the preset buttons (7/9/11/12/13/14/15/17/19/20/21/22) e.g. button (7) until the jog-wheel activating buttons (8/10/16/18) and the pan/tilt buttons (5/6) start to flash.

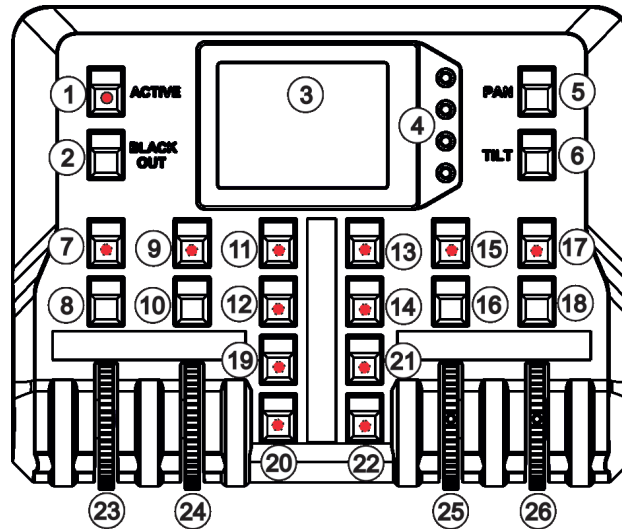

2. Press flashing button of effect which value you wish to add to the current preset (the button will start light continually).

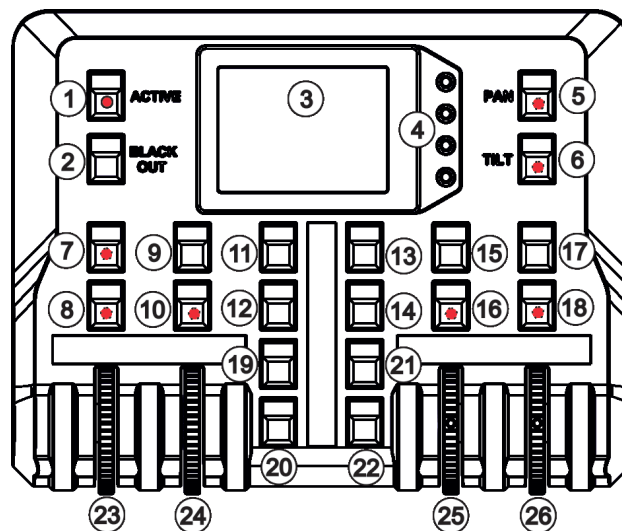

Note: values on faders cannot be included to presets.

3. Press and hold selected preset button until the jog-wheels activating buttons stop to flash. The preset button will light.

Note: Every user preset can have different FollowSpot Controller presets which are saved into the user preset file. This file can be saved on a USB flash drive.

To recall the FollowSpot controller preset

Press a button with stored FollowSpot Controller preset.

To delete the FollowSpot controller preset

1. Press and hold desired preset button until the jog-wheel activating buttons (8/10/16/18) and the pan/tilt buttons (5/6) start to flash.

2. Press and hold selected preset button until the jog-wheels activating buttons stop to flash. Do not press any jog-wheels activating button. The preset button will stop to light.

Note: you can write notes on the white fields of the FollowSpot Controller, use a marker on an alcohol base and a suitable cleaning liquid (on alcohol base) for removing the notes. Never use solvents!

5.6 RoboSpot handles calibration

To calibrate the RoboSpot handles.

1. Install the FollowSpot Controller on the FollowSpot Controller base
1. Deactivate the FollowSpot Controller (button ACTIVE (1) must not light)
2. Move the control handles of the RoboSpot to the calibration position, in this way:
 - pan direction - move handles fully to the left until you reach a stop
 - tilt direction - move handles fully down until you reach a stop
3. Keep handles in the calibration position and press and hold the PAN button (5) for circa 6 seconds until this button makes one flash - it is a finish of the calibration and you can use the FollowSpot Controller.

Middle position

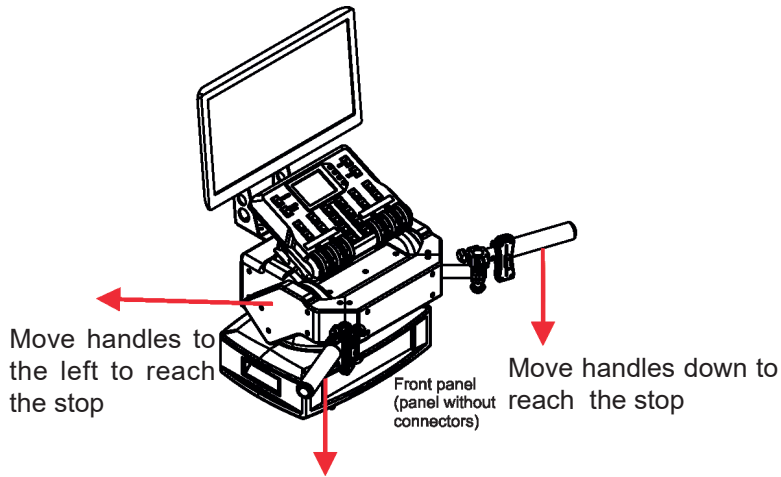

Calibration position

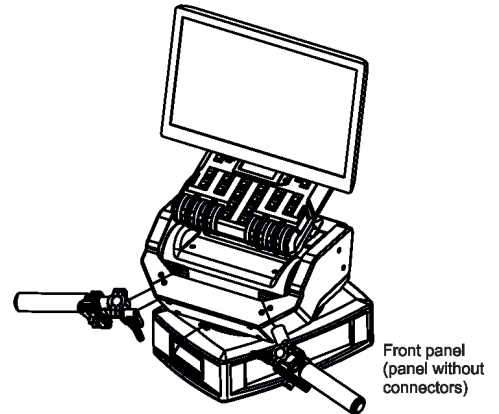

5.7 Multi device control

The RoboSpot can support more fixtures in the follow spot operation.

The fixtures used in the follow spot operation should be placed on a truss around the area intended for the follow spot operation. The fixtures can be placed above stage on one (two or three) side(s) of the stage or around the stage, placing inside the working area for the follow spot operation is not suitable .

Some examples of possible arrangements of fixtures above the stage:

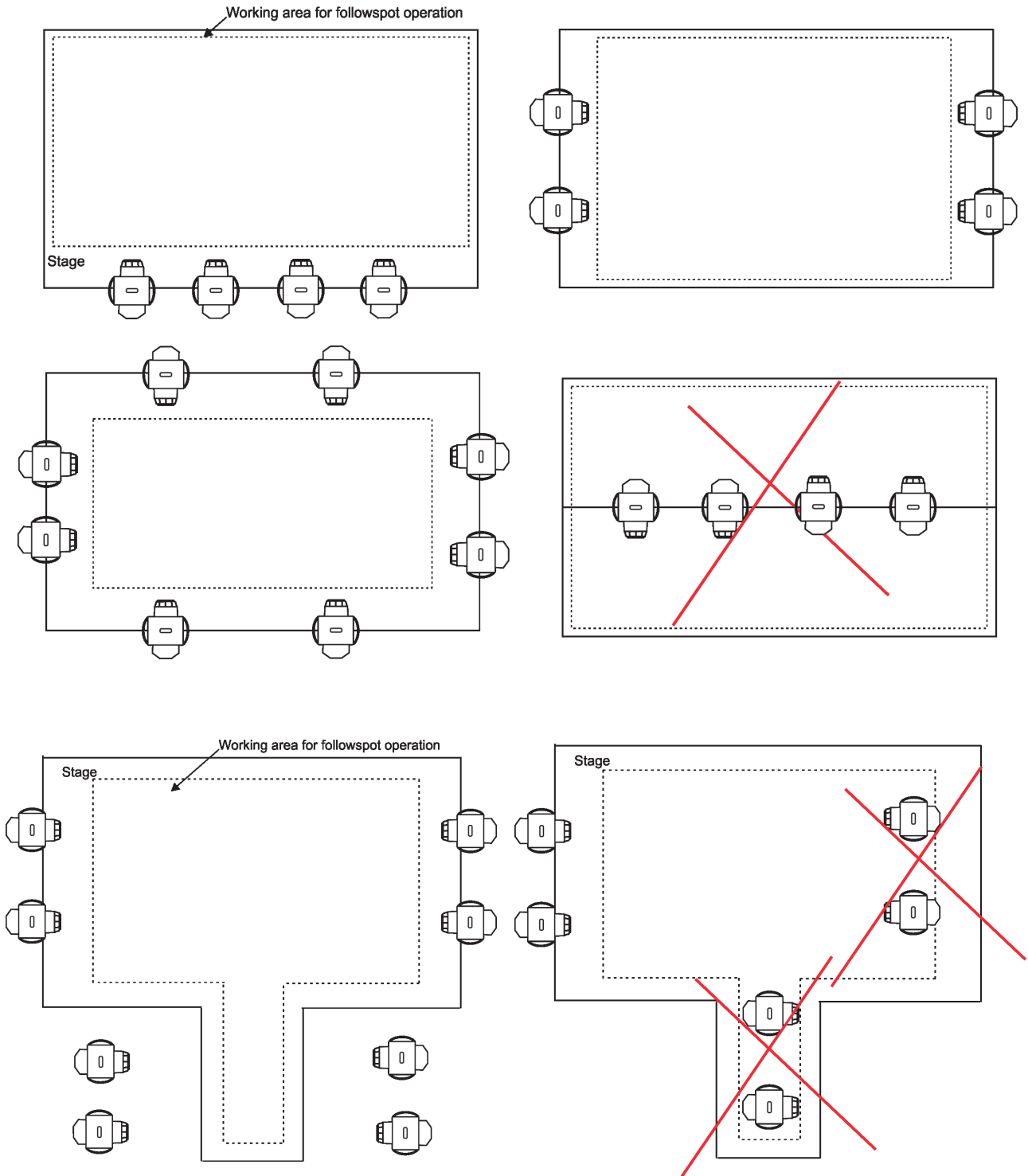

Fixtures cannot stay directly on the stage floor. They have to be placed above the stage floor in two positions only: head downwards or head upwards.

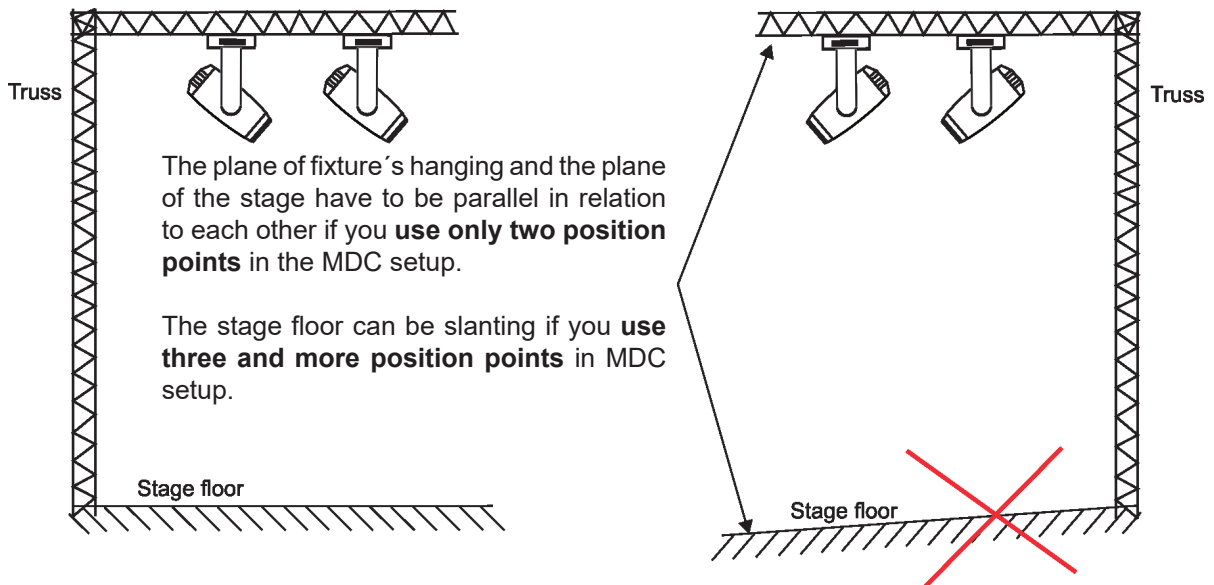
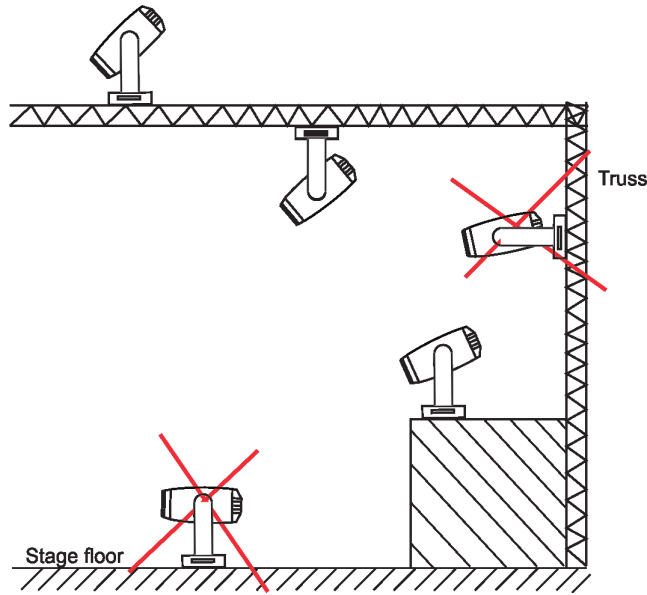

Fixture bases should be aligned on the truss.

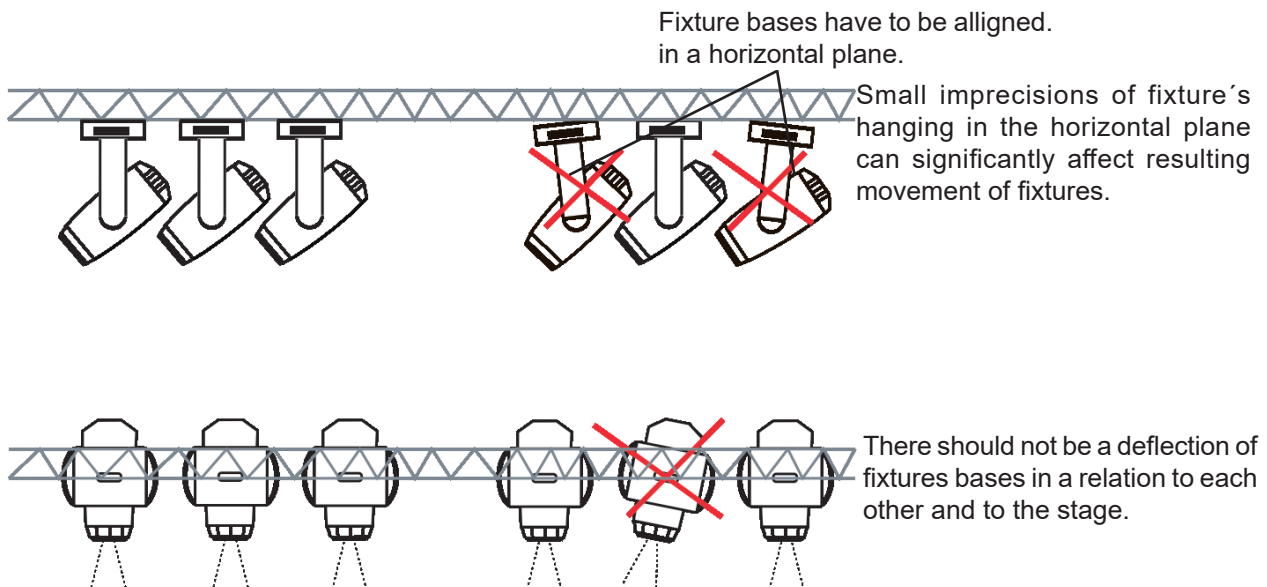

Important notes for the MDC (Multi Device Control) setup

- If you use the Robin BMFL FollowSpot with a camera, do not switch its lamp off and do not close its light output during the MDC setup.
- If you use the RoboSpot Motion Camera, set the red position circle to the centre of the screen before starting the MDC setup.
- The plane of fixture's hanging and the plane of the stage have to be parallel in relation to each other (this condition applies to two position points only).
- Calibration points must be on the same level on the stage.
- Both pan inversion and tilt inversion have to be set OFF before starting the MDC setup a MDC operation. MDC sets inversion automatically, if it is needed.
- Small imprecisions of fixture's hanging in a horizontal plane can significantly affect resulting movement of the fixtures.
- Small imprecisions during MDC setup (calibration points, height) may result in large offsets and inaccurate movement of the fixtures.

If you use the Robin MegaPointe or the Robin Pointe in MDC, both static and rotating gobo wheels are blocked (they cannot be controlled by DMX desk) during MDC setup and the follow spot operation.

There is an example how to create the follow spot operation for three fixtures and two position points. The stage is lighted by the five devices in a row and three of them will be used for the follow spot operation.

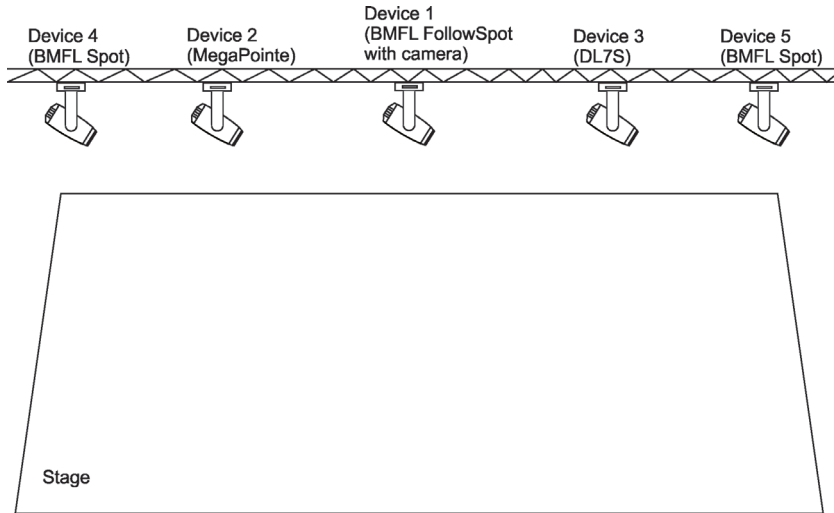

1. Enter the "Multi Dev. Control" menu on the screen and select the option "Setup MDC".
 Note: If you use the RoboSpot Motion Camera, set the red position circle to the centre of the screen before starting the MDC setup.

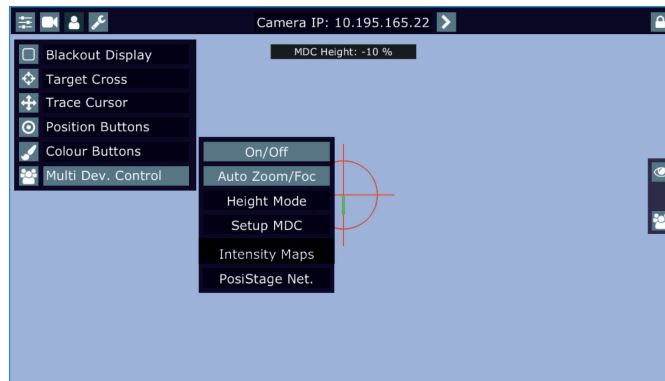

2. After entering the item " Setup MDC" the following message will appear on the screen:

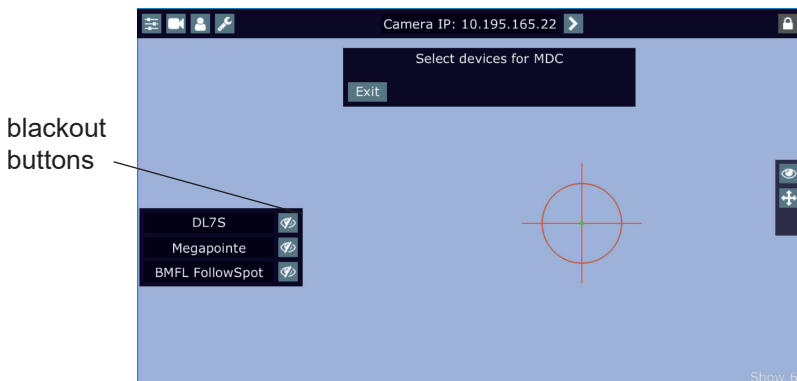

Note: if the option "Auto Zoom/Foc" is not active, the following warning will appear.

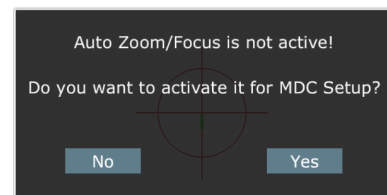

Note: The message "Please Map Zoom and Focus channel to wheels!" reminds you that both zoom and focus have to be mapped jog-wheels of the FollowSpot Controller (only if the option "Auto Zoom/Foc" is active). Select fixtures which will be used for the multi device control (e. g. DL7S, MegaPointe, BMFL FollowSpot).



Exit -cancels Setup MDC
 Next - goes to next step

Selected fixtures are highlighted

Note: In case that setup of MDC has been created, the following message will appear:

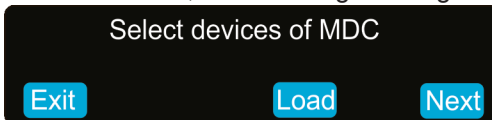

Select the option "Load" if you want to load existing setup and modified it. Touch the "Next" button.

Three fixtures are selected for the multi device operation.



Working area for the follow spot operation

3. The following message will appear on the screen:

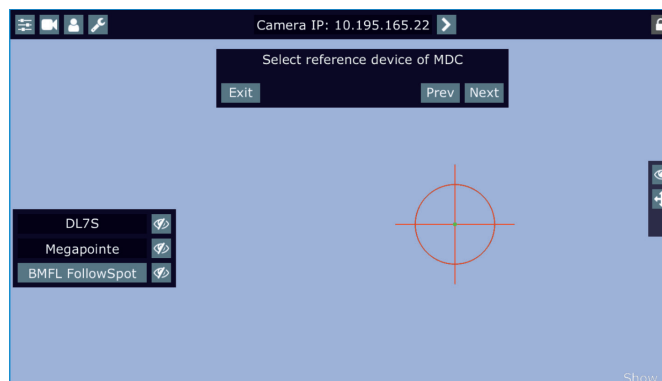

Exit -cancels MDC setup
Next - goes to next step
Prev - goes to previous step

Select desired reference device from devices intended for the multi device control (the reference device should be a device with a camera /BMFL FollowSpot with camera or RoboSpot Motion camera)/ and should not be placed on the edge of fixtures row, optimal position is in the middle of fixtures /if it is possible/, in this case it is the BMFL FollowSpot).

The pan/tilt position of the reference device is directly controlled by means of the RoboSpot handles.

The pan/tilt positions of remaining devices in the multi device control are calculated in relation to the reference device.

Touch the "Next" button.

4. The Following message will appear on the screen:

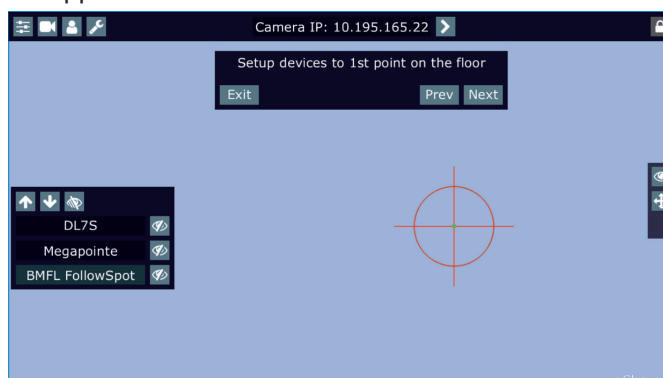

Zoom and iris are automatically set to the narrow beam at all devices used in the follow spot operation. Activate one fixture (by touching its button or using arrows), e.g. BMFL FollowSpot, focus it (by means of the FollowSpot Controller) and aim it to the first point on the floor (by means of the RoboSpot handles) as exactly as possible.

Repeat this action for another two fixtures.

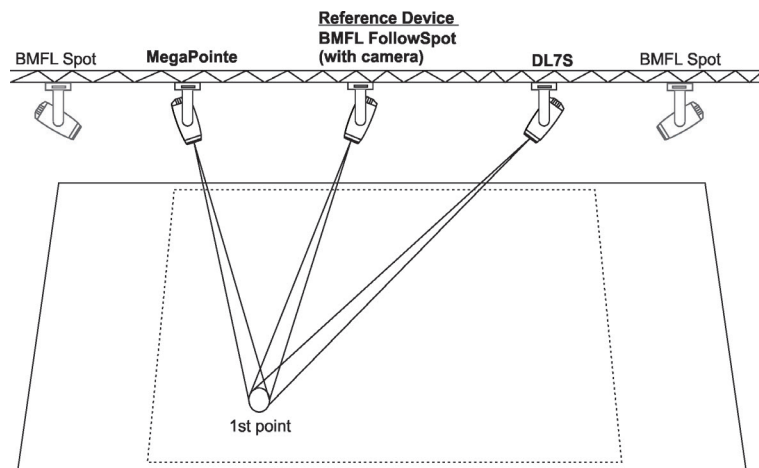
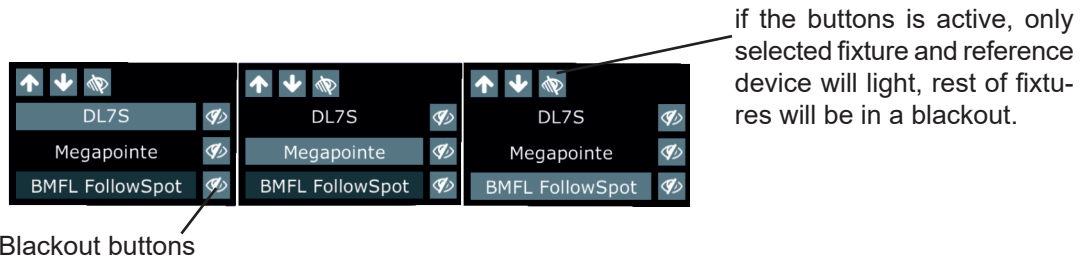

Touch the "Next" button.

5. The following message will appear on the screen:

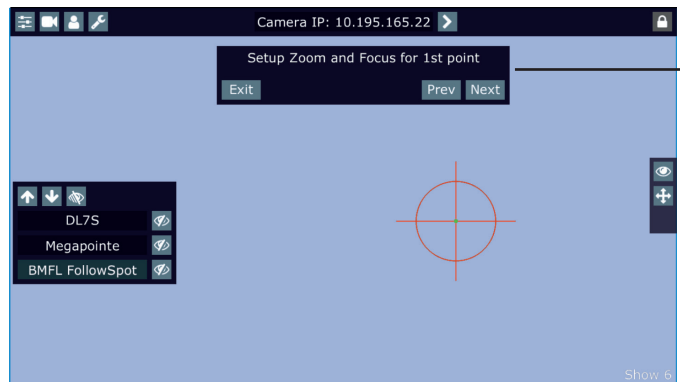

Note: The message will appear in case that the option "Auto Zoom/Foc" is active only.

Use the jog-wheels on the FollowSpot Controller (or faders on the screen) to set desired zoom and focus in the point 1 for each fixture.

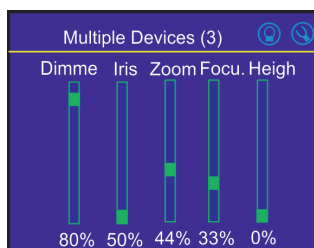

Touch the "Next" button.

6. The following message will appear on the screen:

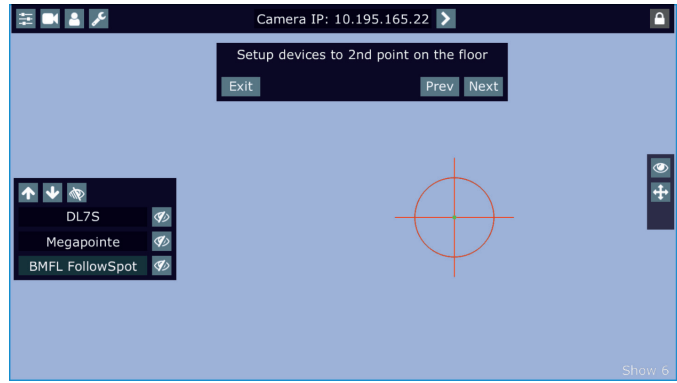

Zoom and iris are automatically set to the narrow beam at all devices used in the follow spot operation. Activate one fixture (by touching its button), e.g. BMFL FollowSpot, focus it (by means of the FollowSpot Controller) and aim it to the second point on the floor (by means of the RoboSpot handles) as exactly as possible. Repeat this action for another two fixtures.

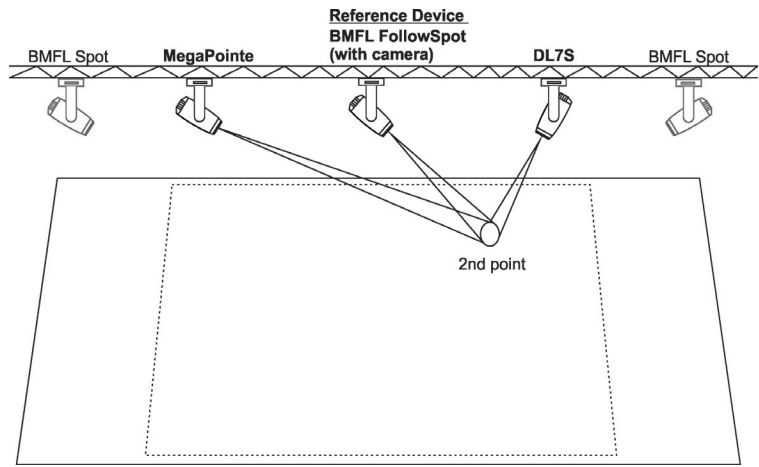

The two points should be placed sufficiently apart on the floor and situated inside the field which is intended for the follow spot operation. The two points should not be placed too close and have to be in the same level on the stage.

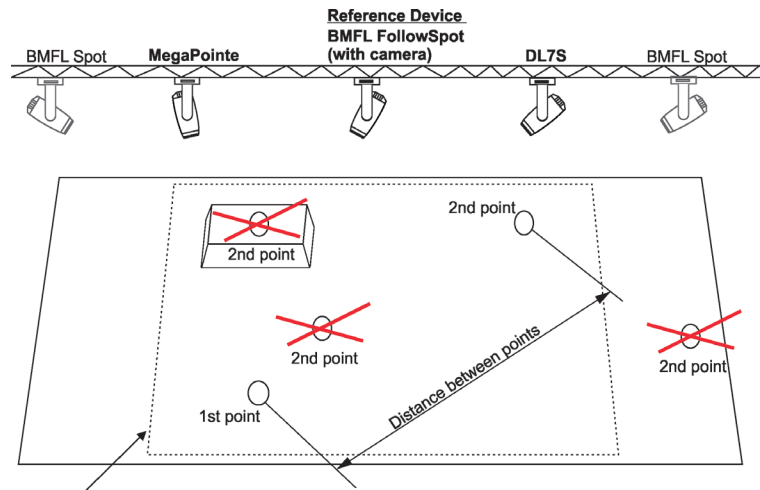

Working area for the follow spot operation

Two position points has to be placed on the stage in a way that all fixtures used in the follow spot operation have to change both pan and tilt values when go (light) from the 1st point to the 2nd point.

In the following example the fixture 3 does not change its pan value (only tilt value) when head moves from the 1st point to the 2nd point, the 2nd point is not selected correctly.

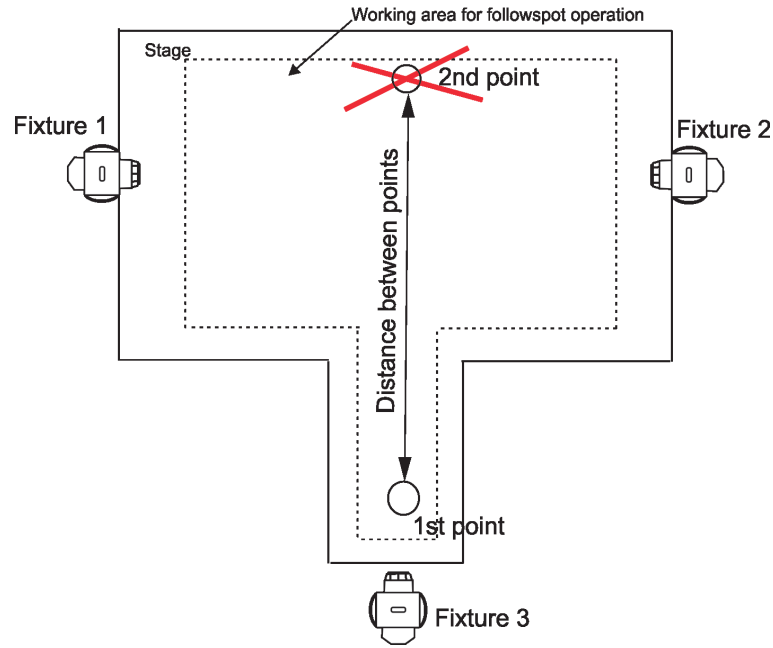

Better position for the 2nd point:

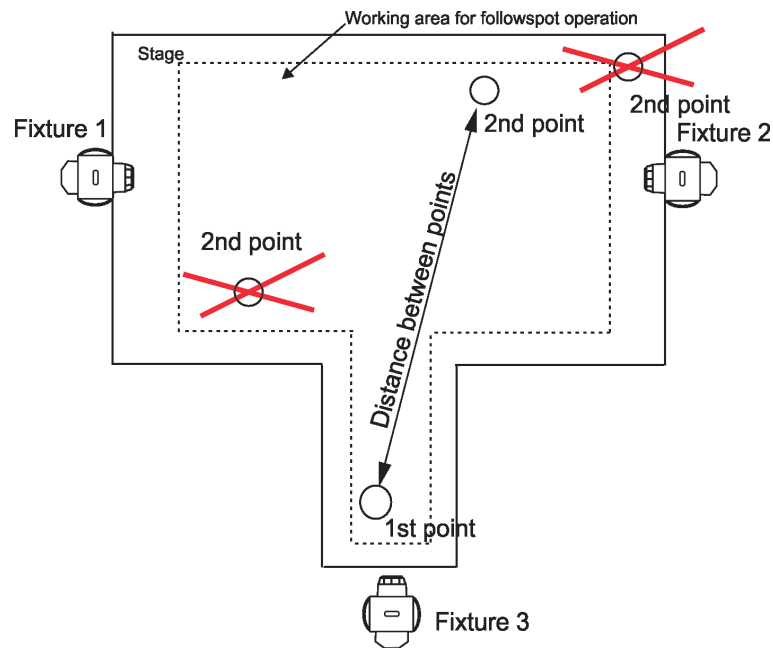

7. Touch the Next button, the following message will appear on the screen:

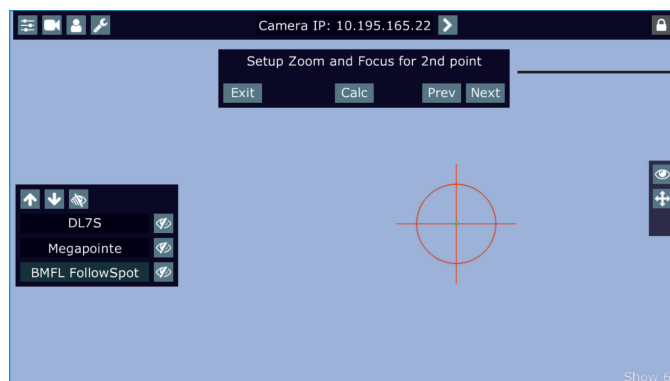

Note: The message will appear in case that the option "Auto Zoom/Foc" is active only.

Use the jog-wheels on the FollowSpot Controller (or faders on the screen) to set desired zoom and focus in the point 2 for each fixture.

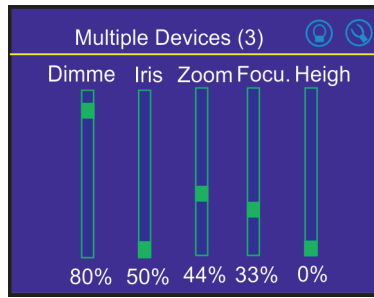

For information: if the option Multi device control is activated, both zoom and focus on all devices are set at 50%. The values are offsets in relation to the zoom and focus values set at the first and the second point.

Touch the "Calc" button.

8. The following message will appear on the screen:

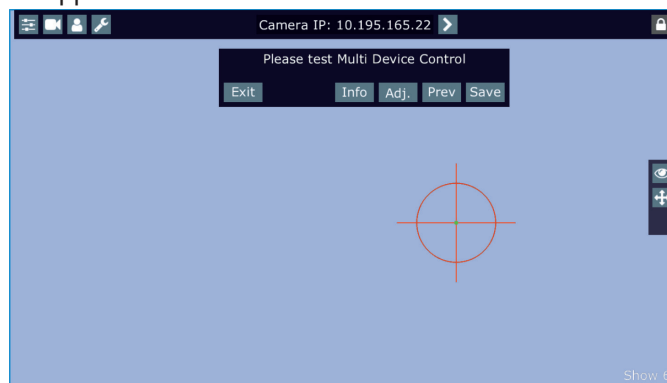

Now you can test the multi device control (by means of the RoboSpot handles). If it is OK, touch the "Save" button or you can use the "Prev" button to move one or more steps back and change setting.

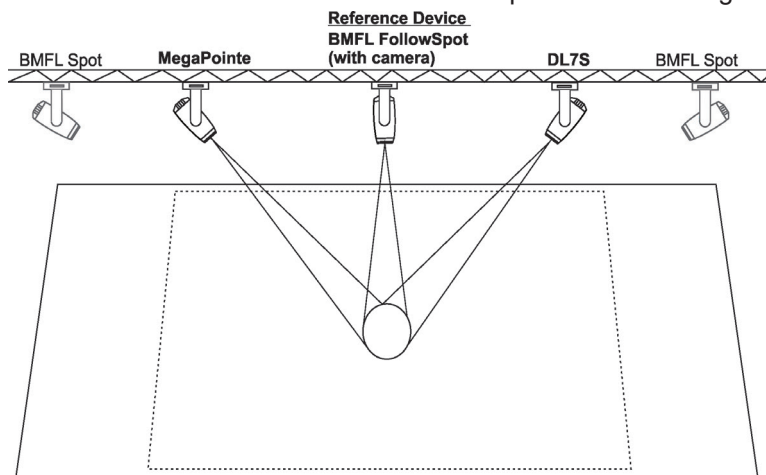

The button "Info" shows information about current positions of fixtures used in the follow spot operation. Example:

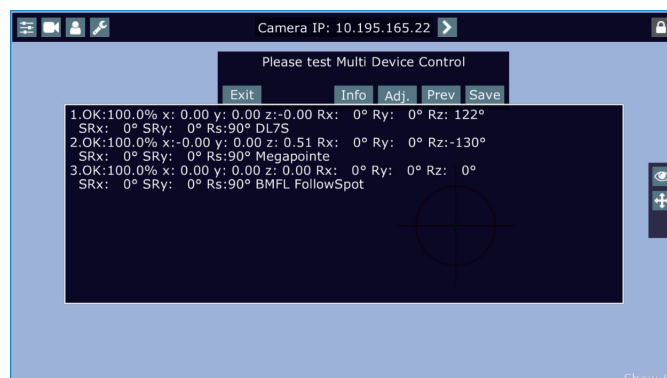

x,y,z - relative coordinates of the device in relation to the reference device
 Rx,Ry,Rz - rotation of the device in x, y and z axes
 SRx, SRy - rotation of the stage towards reference device
 Rs - rotation of the stage towards working space

The button "Adj." allows you to go back in the setting procedure and correct settings of devices in the first and all following points. The following screen will appear.

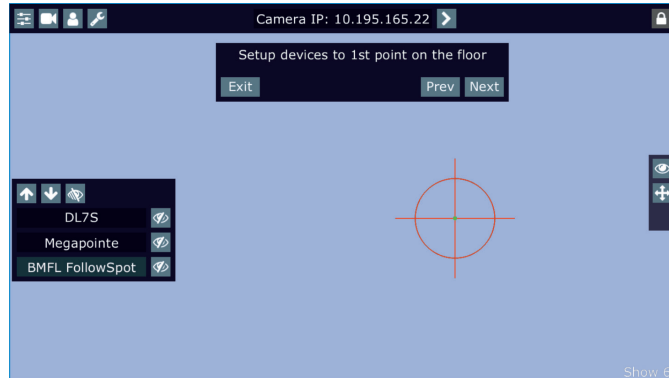

Note:

If the plane of fixture's hanging and the plane of the stage is parallel in relation to each other, two position points should be enough.

If the plane of fixture's hanging and the plane of the stage is not parallel in relation to each other or the result of MDC is not satisfactory, you will need to set another position point (or points).

The MDC setup allows you to set up 5 position points.

To move to the third position point setting, touch the "Next" button.

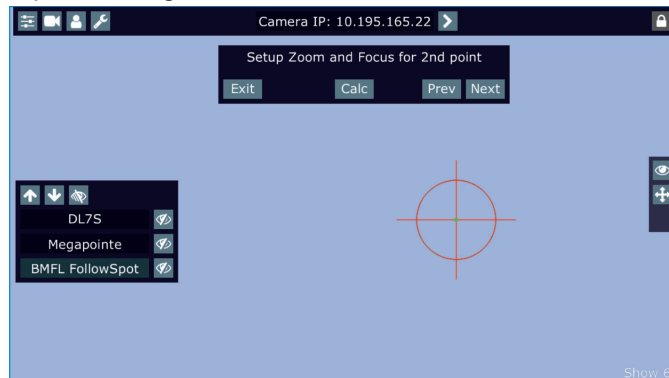

The following message will appear on the screen:

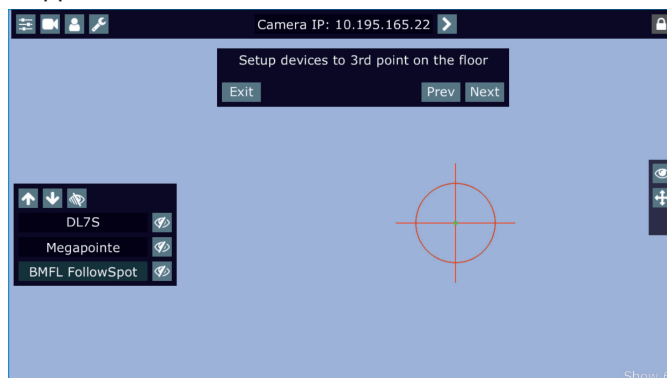

Do settings for the third position point as you did for the second point and check that MDC works correctly.

If you use 3, 4 or 5 position points, they should be placed sufficiently apart on the floor and situated inside the field which is intended for the follow spot operation. They must not be placed too close each other and must be in the same level on the stage (because of correct operation of the function Height mode).

To activate the multi device control, touch the button "On/Off."

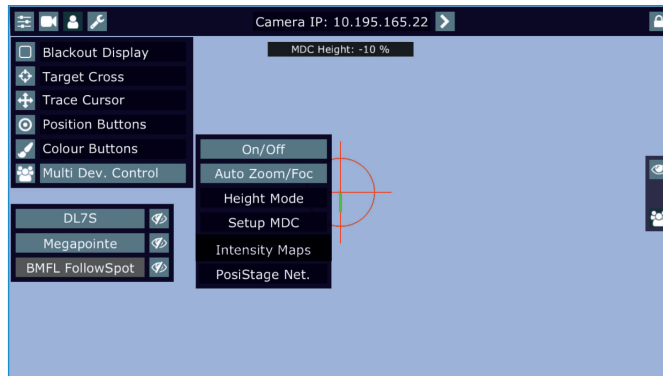
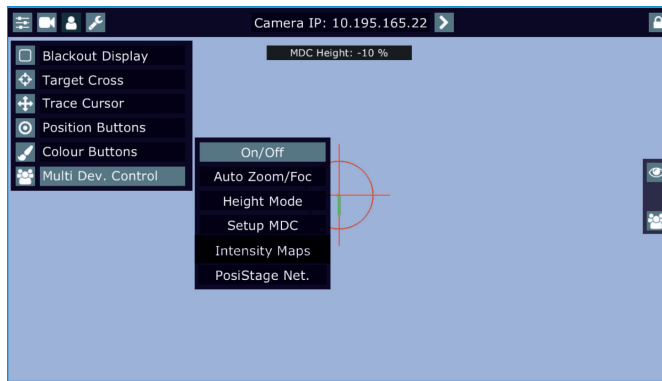

The icon shows fixtures used in the multi device control

If the item "Auto Zoom/Foc." is active, the zoom and focus of fixtures used in the follow spot operation will be carried out automatically (in a range as was adjusted in "1st point" and "2nd point") during moving of the light image on the stage. If the item "Auto Zoom/Foc." is deactivated, zooming and focusing of fixtures has to be done manually.

If the item "Auto Zoom/Foc." is active, neither static gobos nor rotating gobos can be changed at the Robin Pointe/MegaPointe/iPointe (gobos are set to the specific positions). If the item "Auto Zoom/Foc." is deactivated, the gobos can be changed as you need.

During the follow spot operation you can deactivate any device (except the reference device). The deactivated device remains in the original position and the rest of devices will continue in the follow spot operation. When you activate this device back, the device "jumps" to the follow spot operation.

Example: Robin DL7S is deactivated (by touching the button DL7S).

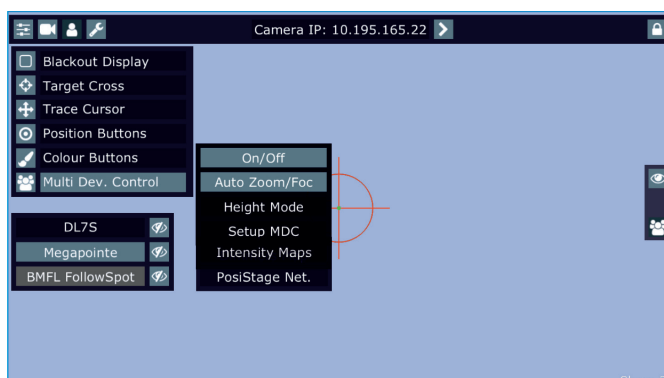

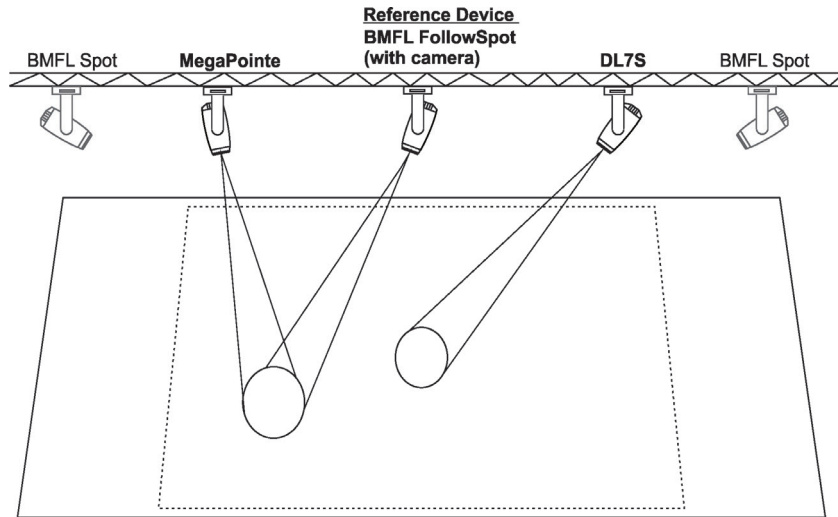

Robin DL7S is activated (by touching the button DL7S).

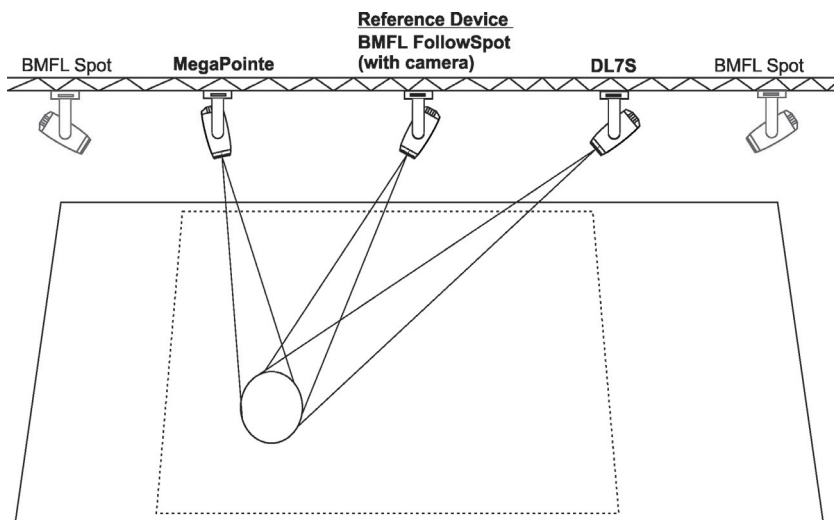
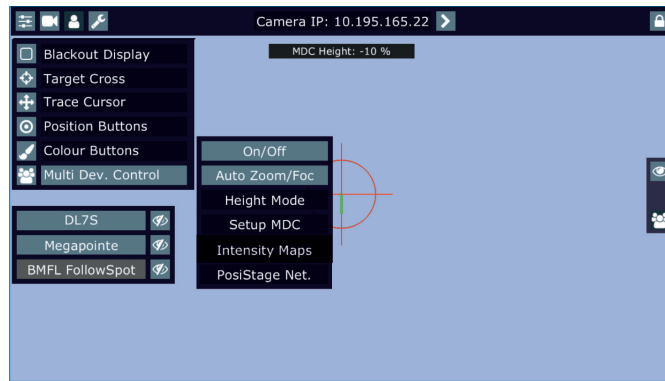

9. When the Multi Device Control is on, select suitable Height Mode.

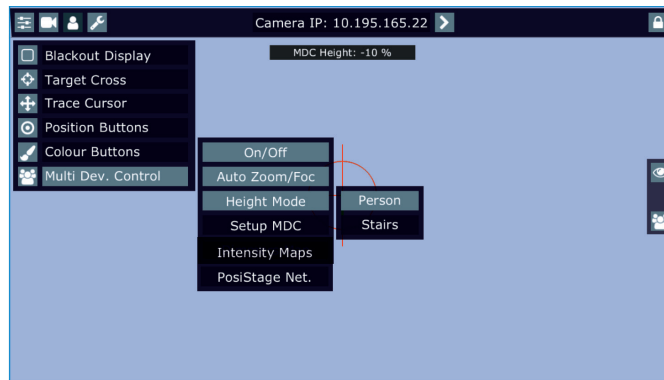

Note: the item Height has to be mapped to some fader or jog-wheel in order to control it during multi device operation.

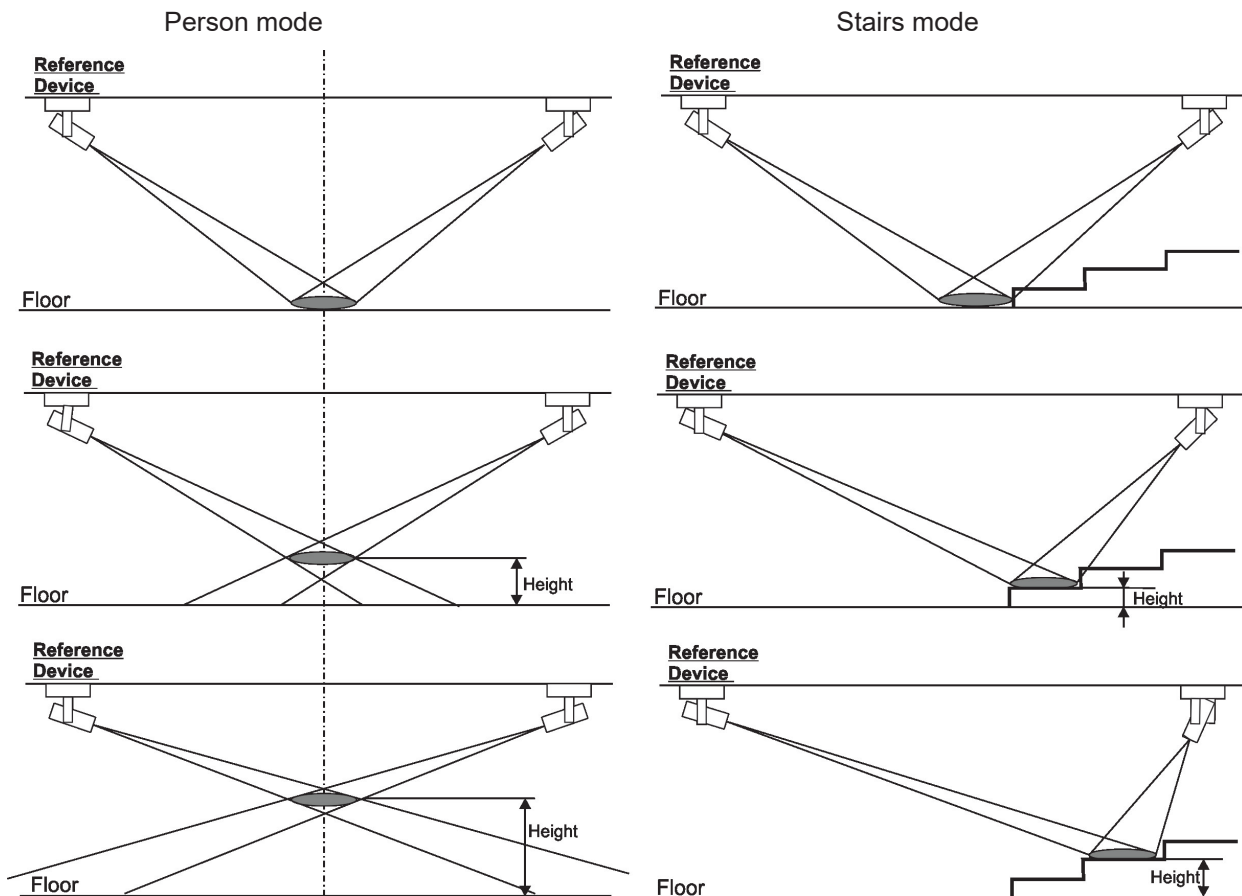

Setting a height range in a multi device control

When you move with a control element (fader or jog-wheel) to which a height is mapped, the height bar with the actual height in % from a stage is displayed on the screen (if the fader or jog-wheel is exactly in the 0% position, the height is not displayed).

Note. The height level range can be set in range of +100% - -100%. Max. value of height (100%) corresponds to the height of the reference device above the stage, 0% corresponds to the stage floor, -100% corresponds to the height "under stage"

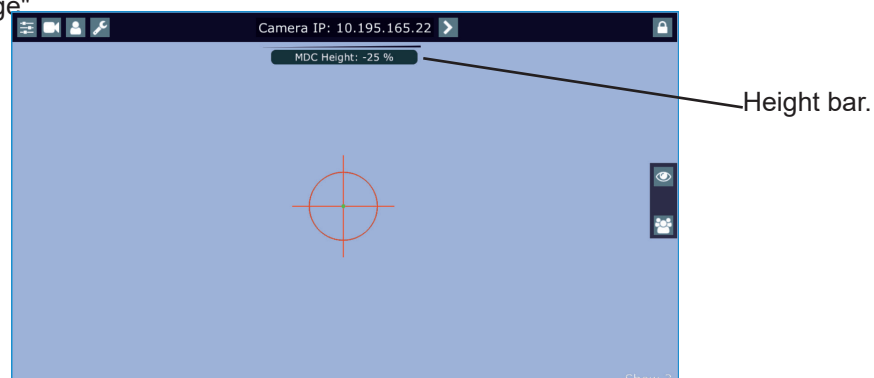

To set the height level range, touch and hold your finger on the height bar until the following message will appear.



Reset button - resets the height range to 0-100% and calls the test screen up.

Use the fader or jog-wheel (according to the height mapping) to set minimum height level and touch the Next button.

The following message will appear.

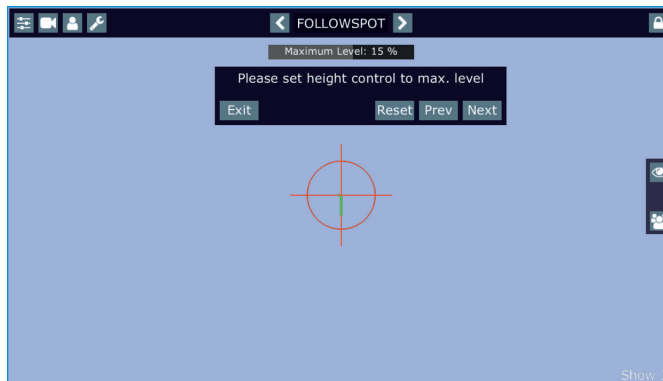

Reset button - resets the height range to 0-100% and calls the test screen up.

Prev button - moves one step back

Use the fader or jog-wheel to set maximum height level. Difference between max. and min. height level has to be 5% or more, from the reason you cannot set the max. level at value < 5% compared to min. level.

Touch the Next button, the test screen with the following message will appear.



Reset button - resets height level to 0-100%.

Prev button - moves one step back

Use the fader or jog-wheel to test the height level range, if it is OK, touch the Save button to save the height level range.

Note. The fader (or jog-wheel) uses its full track for control of the height level range.

E.g. Height level range is set 0% - 10%

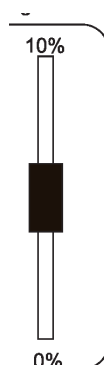

Examples of height level ranges.

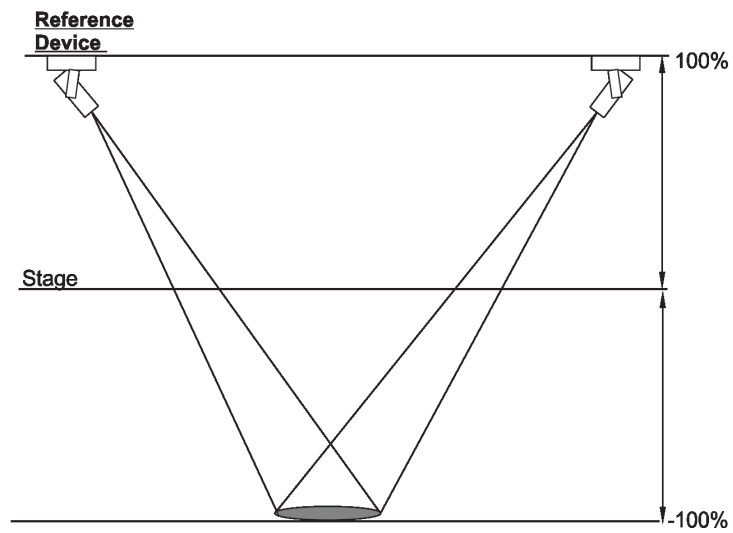
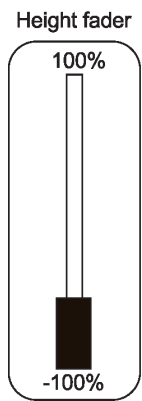
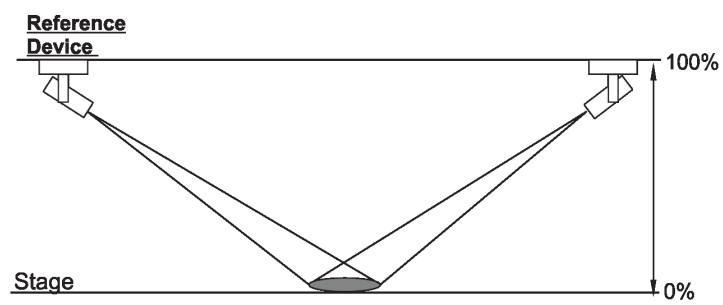
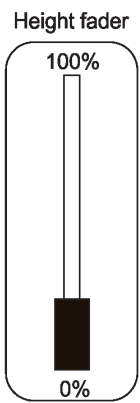
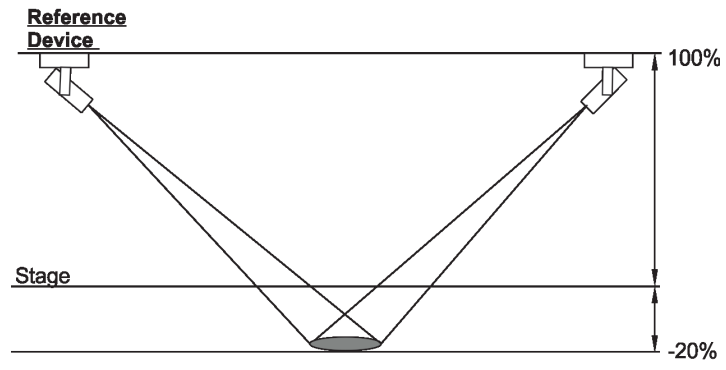

5.8 Dimmer and iris maps

The RoboSpot allows you to set a light intensity and iris aperture in different points of the area intended for the follow spot operation. The light intensity and iris aperture can be set separately for each fixture used in MDC operation. Both functions are saved under menu item "Intensity Maps"

Setup

Before doing dimmer maps and iris maps, map height, iris and dimmer channels to jog-wheels (not to faders!) Go to the menu "Multi Dev. control " and select the option "Intensity Maps".

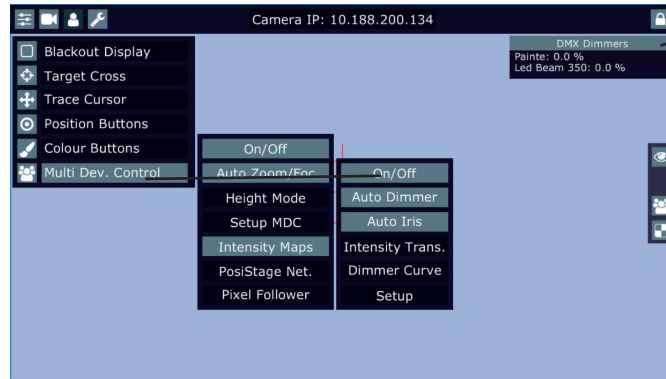

The window shows current values of fixture's dimmers (item DMX Dimmers in the menu Service has to be active).

Menu item "On/Off" activates dimmer maps and (or) iris maps. During setup the item has to be on.

Menu item "Auto Dimmer" activates dimmer maps.

Menu item " Auto Iris" activates iris maps.

If you want to setup both dimmer maps and iris maps, items "Auto Dimmer" and "Auto Iris" has to be activated (highlighted).

Touch the menu item "Setup" and the message "Please map Dimmer, Iris and Height channels to wheels" will appear reminding you a need of mapping of dimmer, iris and height channels to jog-wheels.



By touching the screen, the message " Please map Dimmer, Iris and Height channels to wheels" will disappear.



Load button - loads position from last Dimmer (Iris) Maps Setup.

Use the RoboSpot's handles to aim the light beam to desired first position point (position points in the Dimmer and Iris Maps Setup may be different from position points used in MDC setup) and touch the "Next" button. The following screen will appear.

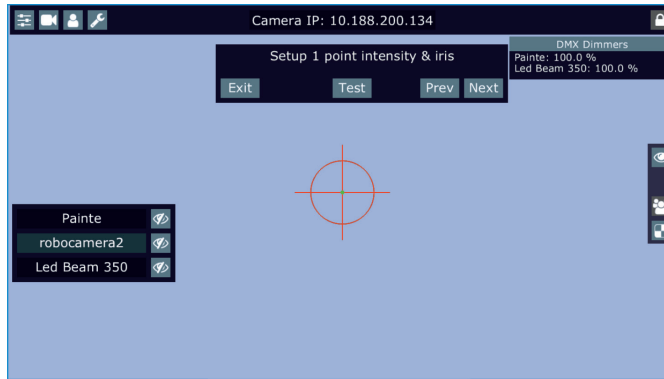

Test button - activates dimmer (iris) setting which you have made in the first step.

Prev button - moves one step back.

Now set desired light intensity and iris for each fixture (activate fixtures one by one by touching them). E.g.

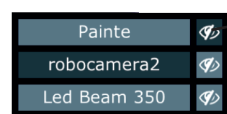
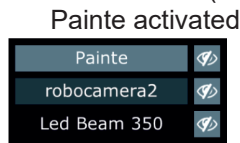

The button activates/deactivates light output from the fixture

After setting the light intensities and iris aperture, touch the "Next" button. The screen for the second point will appear.

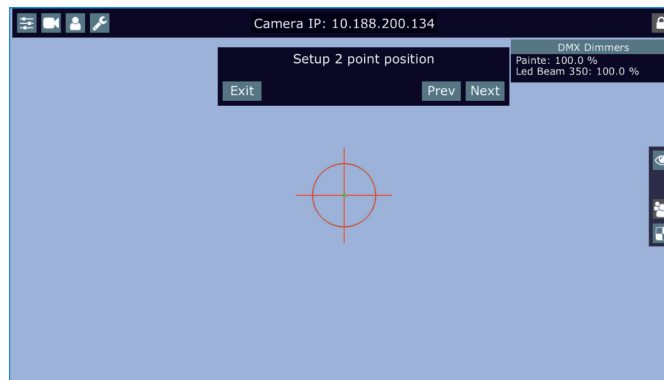

Use the RoboSpot's handles to aim fixtures to desired second position point and touch the "Next" button. The following screen will appear.

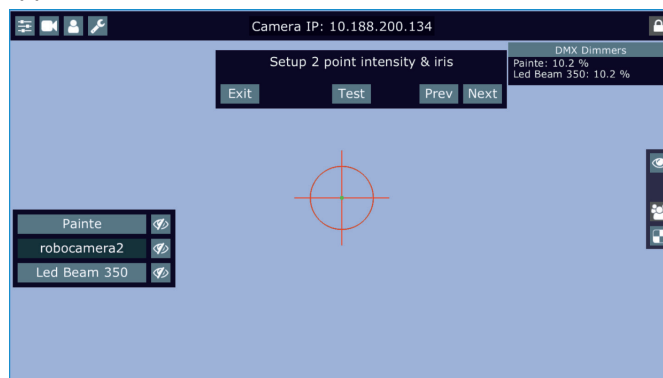

Test button - activates dimmer and iris settings which you have made in the current step and previous step(s).

Prev button - moves one step back

Set desired light intensity and a dimmer aperture for each fixture (activate fixtures one by one by touching them). In this way you can select up to 20 position points and set the light intensity and iris aperture in them.

After setting the light intensity and iris aperture in last position point (e.g. point 4), touch the "Test" button and the following screen will appear.

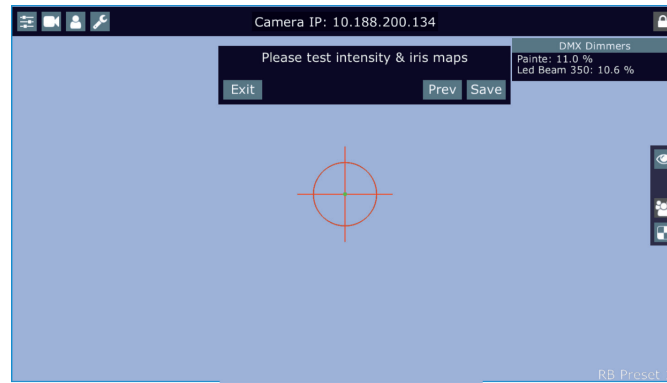

Move the light beam to desired positions (by means of the RoboSpot's handles) and test the light intensity and iris aperture in these positions. If it is OK, touch the "Save" button to save set values to the RoboSpot.

Note:

During MDC operation, the light intensity of each fixture cannot be set above its intensity set in the Dimmer Maps Setup, while iris aperture set for each fixture in the Iris Maps Setup can be changed around its set value up or down.

Example for Dimmer Maps Setup.

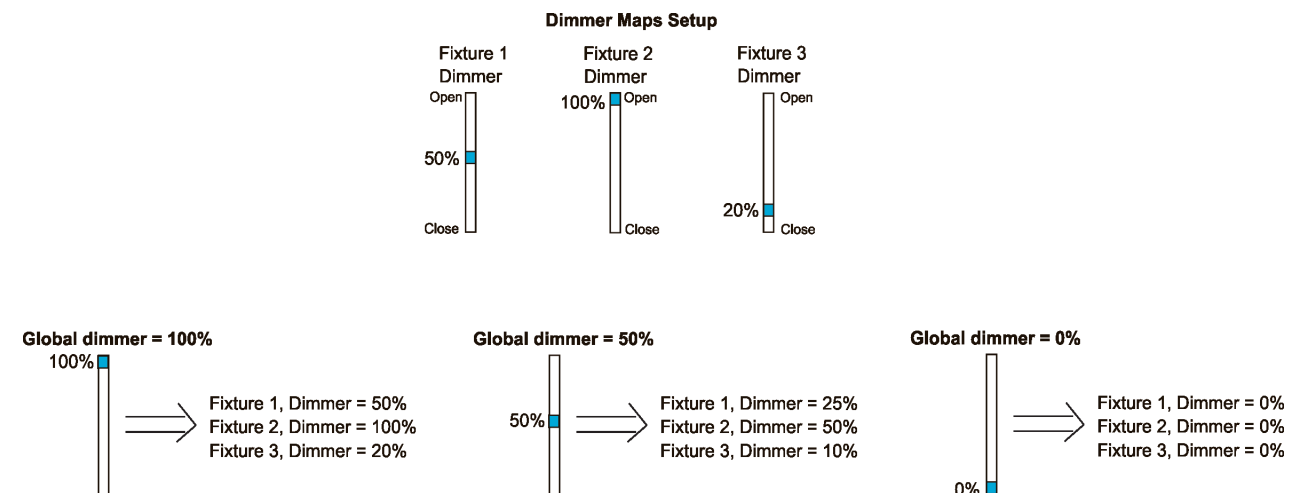

By means of the global dimmer you can only decrease light intensity of individual fixtures.

Example for Iris Maps Setup.

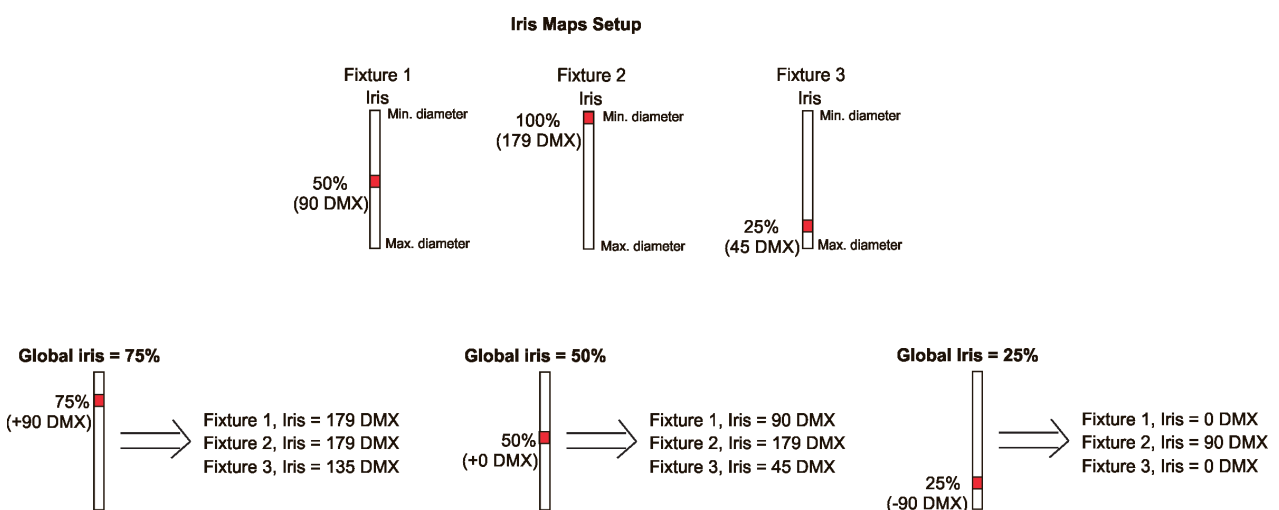

Iris values set in the Iris Maps Setup are offsets to which is added value set at a global dimmer.

Global dimmer range: 0%= -179 DMX, 50%=0 DMX, 100%=+179 DMX.

E.g. Global iris =75%, Fixture 3, real Iris DMX value is: 45 (offset) + 90 = 135 DMX.

Global iris =50%, Fixture 3, real Iris DMX value is: 45 (offset) + 0 = 45 DMX.

Global iris =25%, Fixture 3, real Iris DMX value is: 45 (offset) - 90 = 0 DMX.

Setting the dimmer curve

The menu Dimmer Curve allows you to select a linear or square law dimmer curve. Selected dimmer curve applies to all fixtures used in MDC setup.

When you switching between dimmer curves, the message " Setting dimmer curve for MDC lights to linear" or " Setting dimmer curve for MDC lights to square law" will appear for a while informing you that command for activation of selected dimmer curve has been sent to fixtures.

Note. The message stated above also will appear when you activate the Intensity Maps (item On/Off)

Dimmer curves in individual fixtures are temporarily overwritten (by means of a command on the channel Power/ Special Functions).

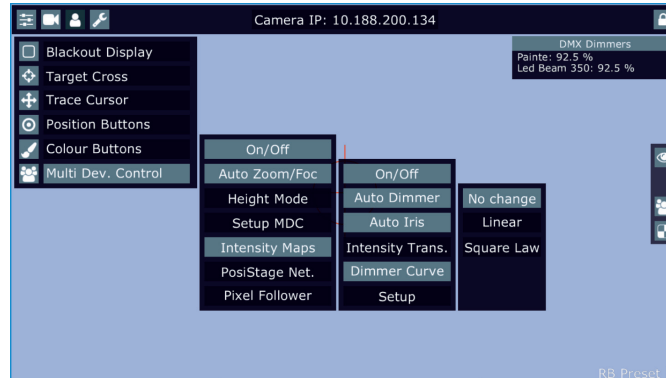

Note: if you select a dimmer curve and then you switch some fixture off and on, the fixture will use a dimmer curve set in the display menu of this fixture (not curve set in the "Dimmer Curve" menu).

Intensity transition

The menu Intensity Transition offers you three modes (Smooth, Medium, Sharp) of a "light transition" from one position point to another.

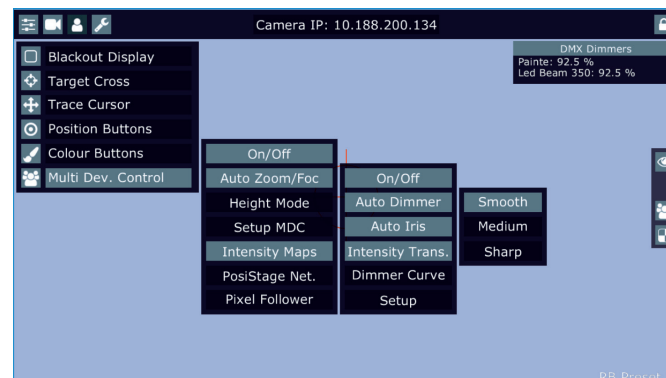

There is a picture illustrating differences among the three modes.

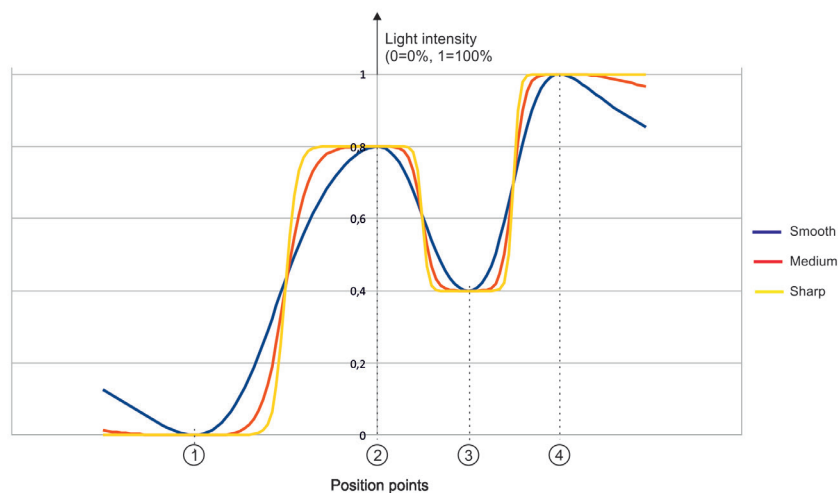

The light intensity in the Smooth mode decreases faster around position point during movement from one position point to another than in the Medium or Sharp mode.

5.9 Using Footsies in MDC operation

Special setting procedure allows you to use ROBE footlight fixture Footsie in MDC operation. Footsie is available in two models. Footsie 1 has two individually controlled pixels (zones) and Footsie 2 has four individually controlled pixels (zones).

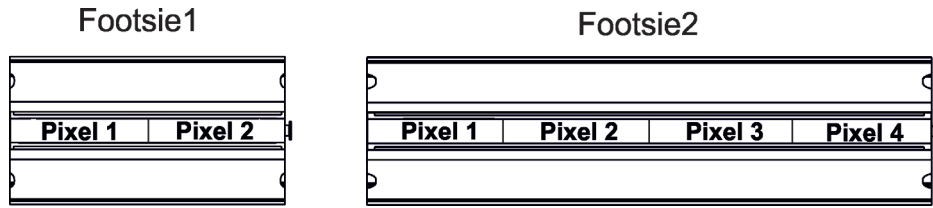

Example of Footsies connection

Note: Ethernet Switch has to be connected to the CAMERA input of the RoboSpot.

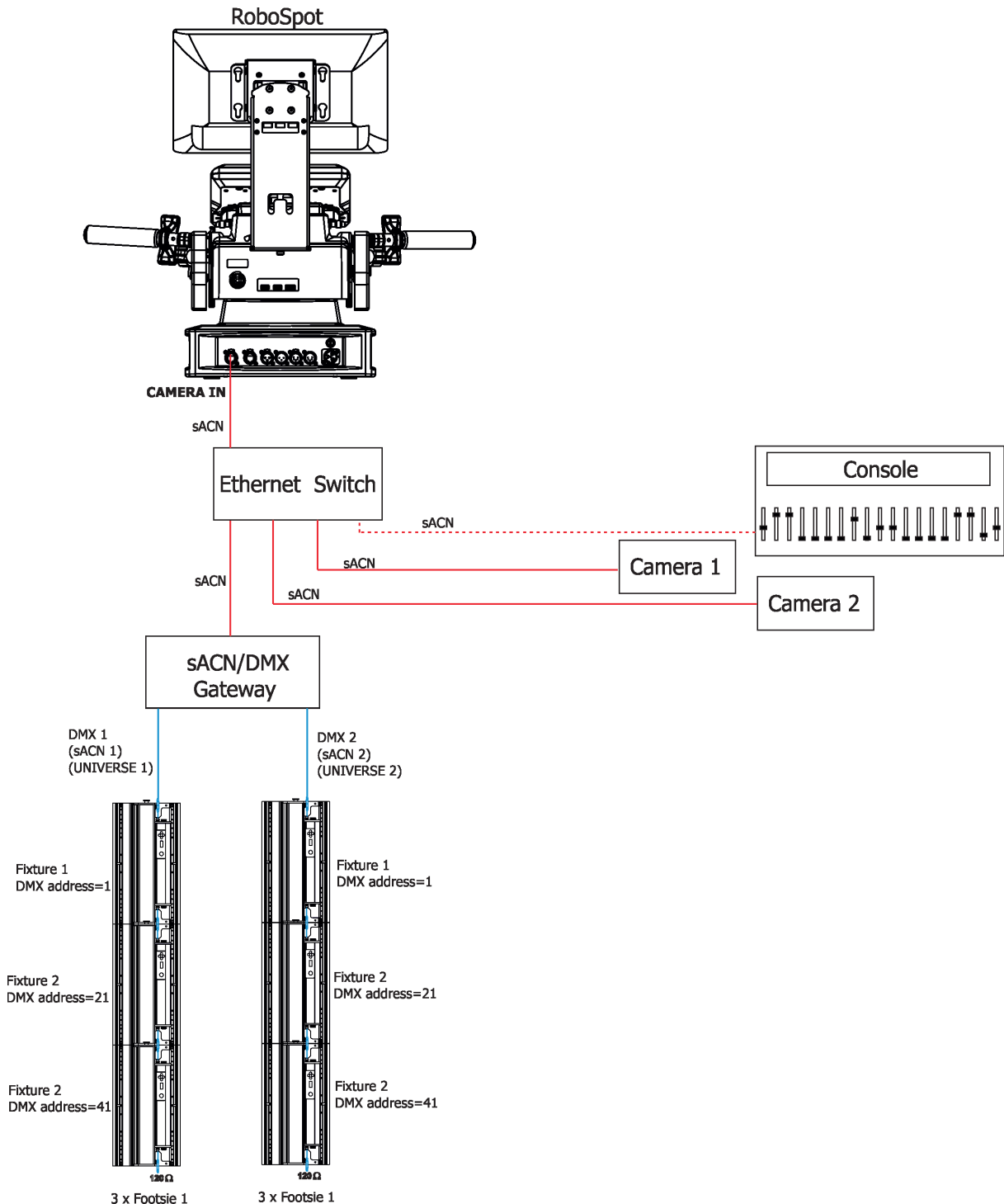

As sACN/DMX gateway can be used e.g. ArtLynchx Quad, its Port Settings should be the following.

Artistic Licence
artLynch quad
(artLynch quad)

IP Settings

Edit

IP Address Mode Default Static Ad

IP 2.138.78.112

Subnet Mask 255.0.0.0

Gateway 255.255.255.255

Save

Online ●

Power ●

Net ●

Port Settings

Port	Input	DMX	RDM	Delta	Universe	Rate	Protocol	Merge	Label
1	<input type="checkbox"/>	<input type="radio"/>	<input checked="" type="checkbox"/>	<input type="checkbox"/>	1	High	sACN	HTP	Port 1
2	<input type="checkbox"/>	<input type="radio"/>	<input checked="" type="checkbox"/>	<input type="checkbox"/>	2	High	sACN	HTP	Port 2
3	<input type="checkbox"/>	<input type="radio"/>	<input checked="" type="checkbox"/>	<input type="checkbox"/>	3	High	sACN	HTP	Port 3
4	<input type="checkbox"/>	<input type="radio"/>	<input checked="" type="checkbox"/>	<input type="checkbox"/>	4	High	sACN	HTP	Port 4

Advanced Information

CID 926CB9D9-9981-A936-94F6-9D20296552F1

Management UID 414c:c9014e70

RDMnet Scope default

Integrity index 85616

MAC Address 00:06:a6:01:4e:70

Firmware Version Revision 3.45

Last Diagnostic Message AL6k driver. Current IP: 2.138.78.112 Current subnet: 255.0.0.0 Current default gateway: 255.255.255.255

Node Report #0001 [4] Initialise completed.

Option Merge should be set to HTP

To integrate Footsies to MDC.

1. Activate the menu "Multi Dev. Control" on the monitor screen.

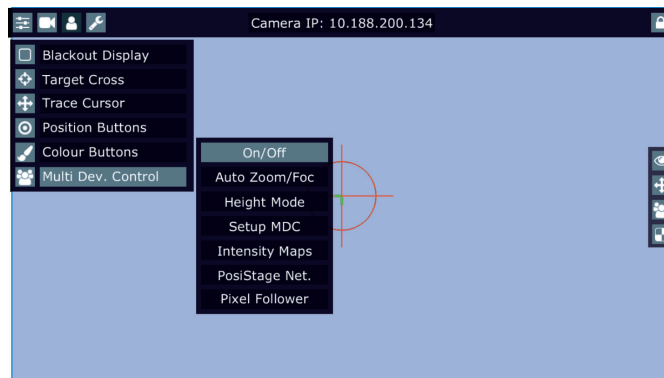

2. Select option "Pixel Follower" and activate it by means of item On/Off.

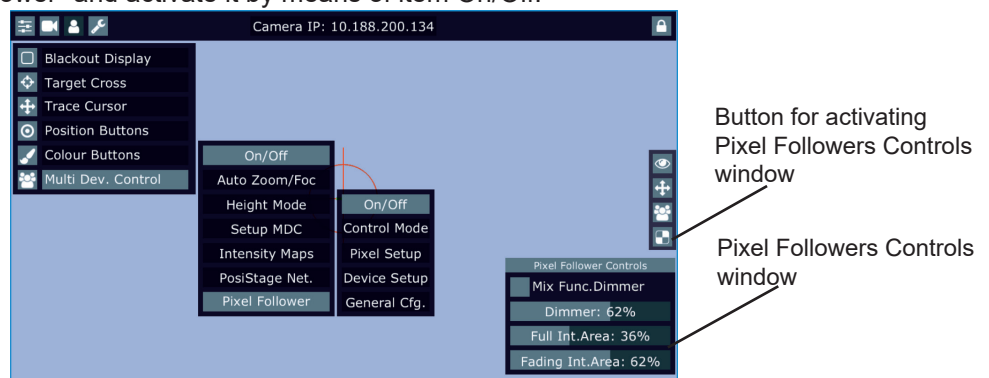

The Pixel Followers Controls window will appear in the right bottom of the screen and its icon in the Action toolbar on the right side of the screen.

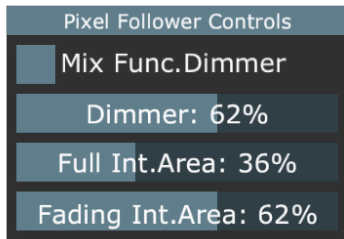

By touching some item and moving finger on the screen changes value at the item.



Mix Func. Dimmer - pixel dimmer is mixed with a dimmer assigned to the fader or jog-wheel on the RoboSpot.

Dimmer - pixel dimmer.

Full Int. Area - inside the area LEDs of current pixel light on max. intensity (100%)

Fading Int. Area - inside the area LEDs of current pixel start gradually increase light intensity from 0% intensity to 100% intensity at reaching Full Int. Area.

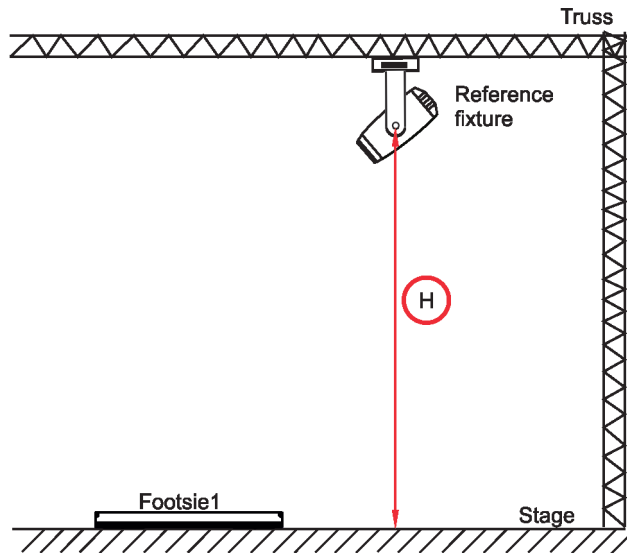
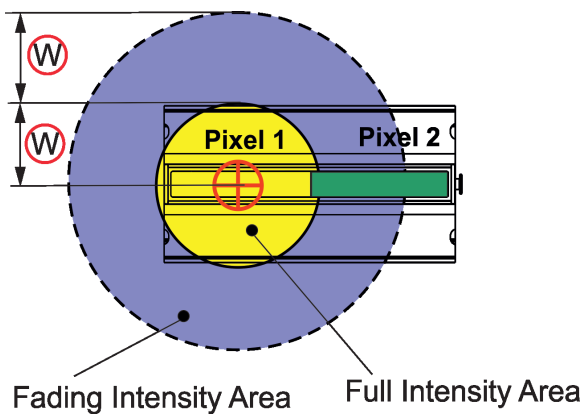

Width (W) of both areas is a relative number denoted in % and it is derived from the height (H) of reference fixture above the stage floor.

$$W = H/2. \text{ (at 100\%)}$$

In fact full intensity areas and fading intensity areas partially overlap. Size of overlapped areas depends on setting the item " Full Int. Area" and "Fading Int. Area".

Example for two pixels:

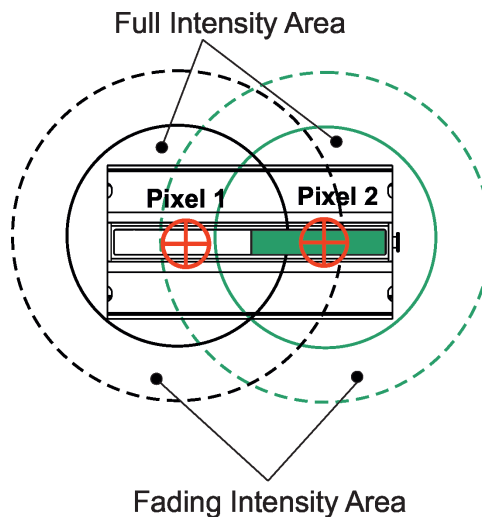

Examples for different sizes of light intensity areas:

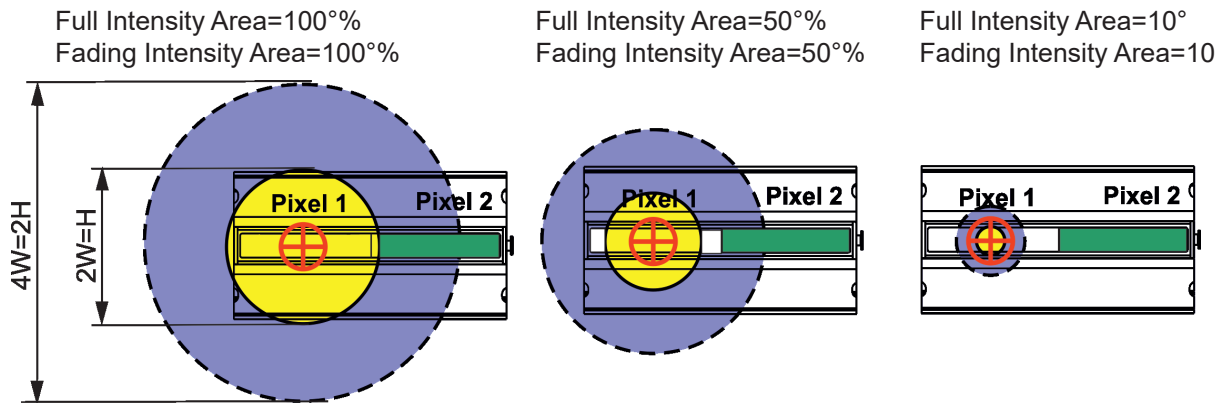

Full Intensity Area=100%
Fading Intensity Area=0%

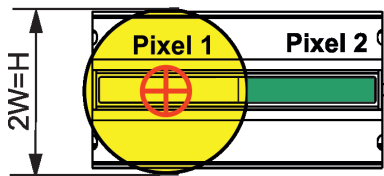

Full Intensity Area=0%
Fading Intensity Area=100°

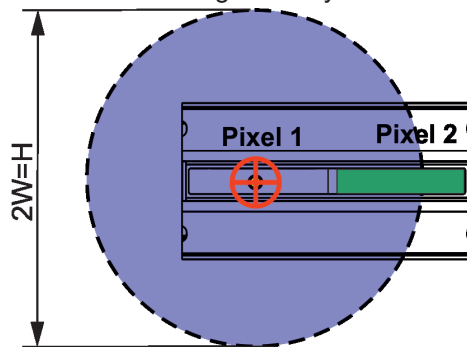

Full Intensity Area=100%
Fading Intensity Area=50%

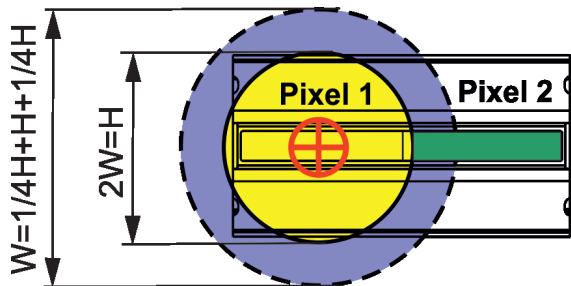

3. Select option "Device Setup" from menu Pixel Follower and the Device Setup window will appear.
Example:

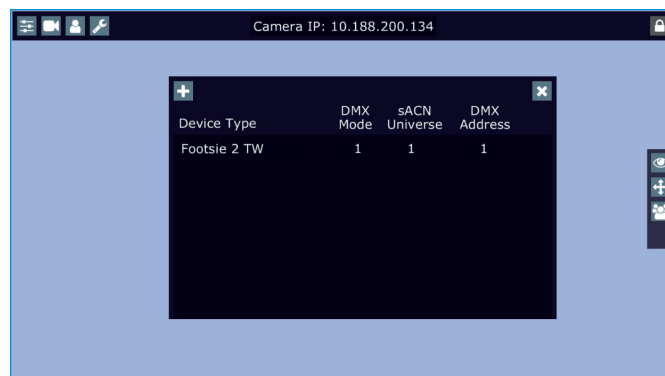

Device Type - the option allows you to select desired device (e.g. Footsie 2 TW).



You can change personalities of selected device by touching value under items "DMX Mode", "sACN Universe" and "DMX Address".

Example for DMX mode change screen:



By touching the icon  you can add another device to the list of devices.

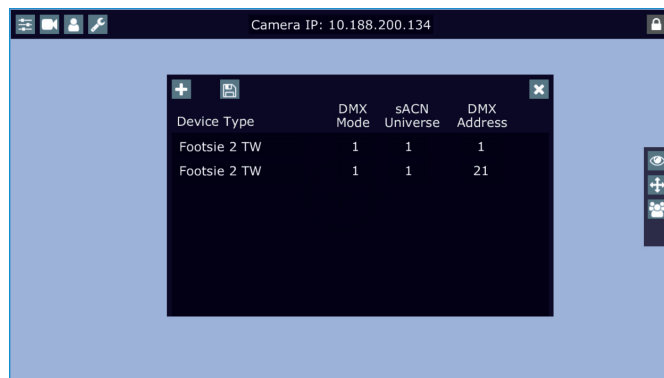

DMX address (21) of second device is automatically derived from setting of the first device (DMX address1). **Order of devices in the window should correspond to the real order of devices and their types in the line of Footsies.**

After setting all devices, touch the icon  to saves Device Setup to the show file in the RoboSpot and touch the icon  to leave Device Setup window.

4. Select option "Pixel Setup" from menu Pixel Follower and the following screen will appear.
 Example for one Footsie 2 TW:

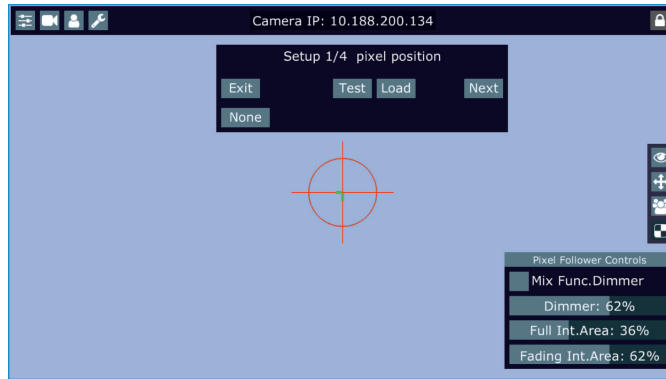

Select type of pixel shape (Circle, Line, Ellipse Rectangle) by touching the item None.

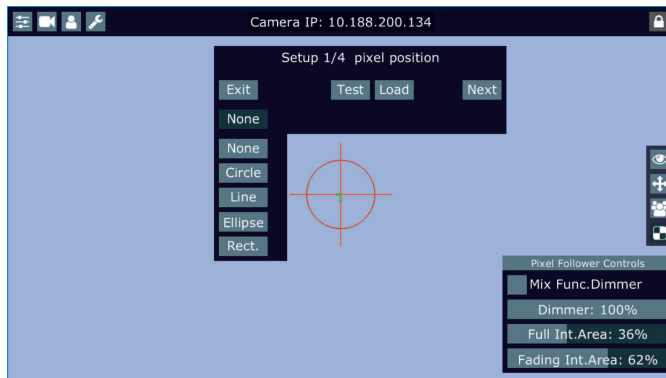

Option None means that pixel is not active.

Pixels overview

(Pictures below are two-dimensional, for illustration only.)

Circle

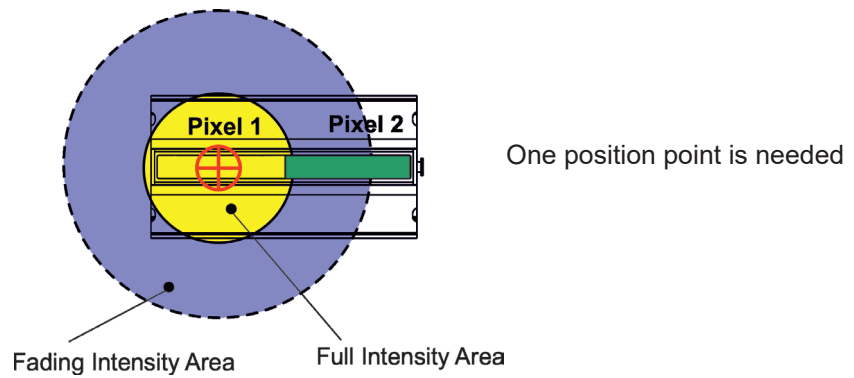

Line

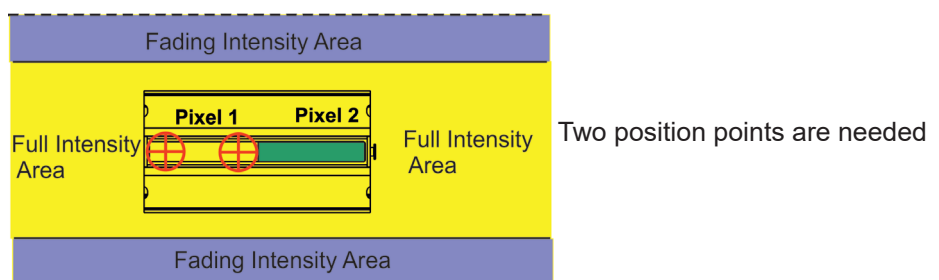

Ellipse

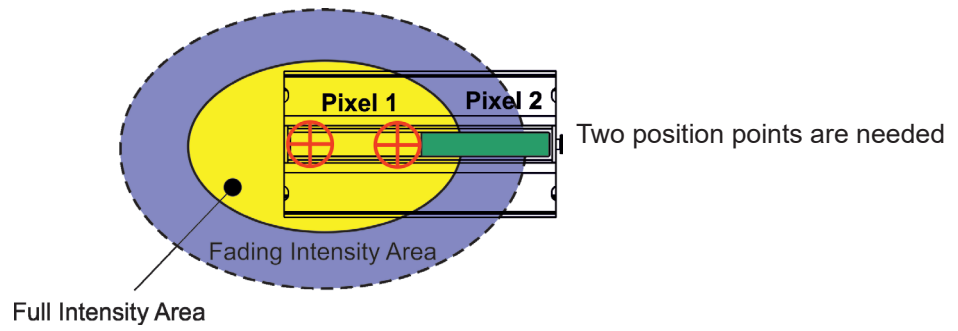

Rectangle

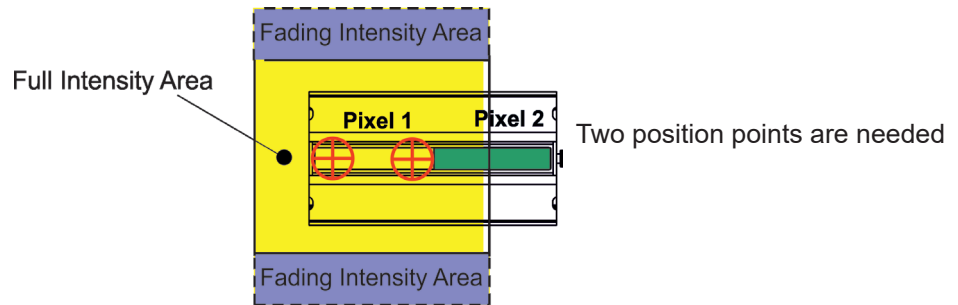

Example for pixel shape Circle

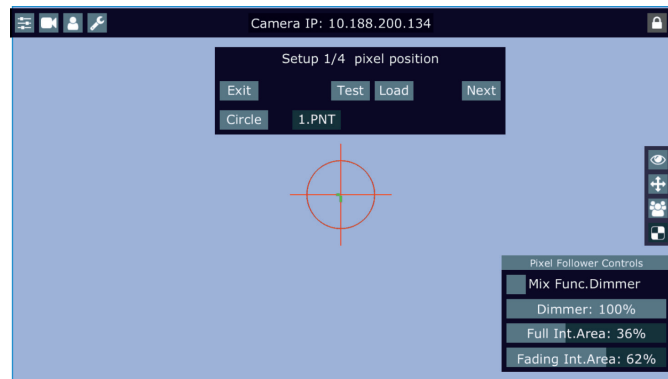

By means of the control handles move the position circle to desired position point of the pixel 1 of the Footsie 2 TW and touch the button Next.

Move the position circle to desired position point of the pixel 2 of the Footsie 2 TW. Repeat this procedure for pixel 3 and pixel 4.

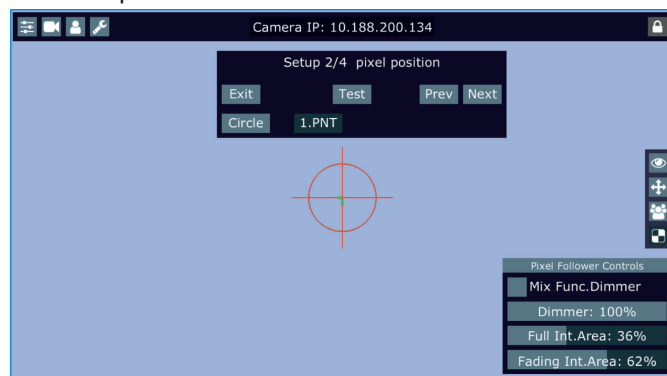

Button Exit - allows you to leave Pixel Setup without saving values.

Button Test - allows you to check position points of each pixel. This option you can utilize at each pixel, not only at last pixel.

Button Load - allows you load already once created Pixel Setup

Button Prev - allows you to move one step back (previous pixel)

Button Next - allows you to move on next step (next pixel)

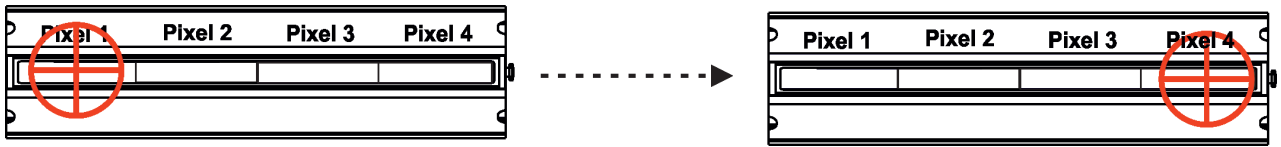

Location of position points of pixels depends on your needs, they can be out of fixture pixels if you wish it.

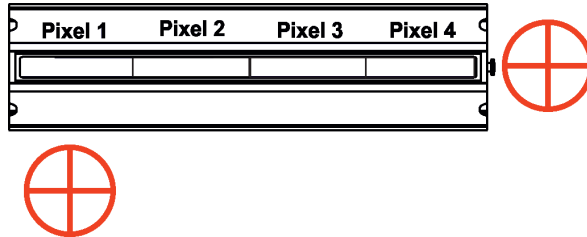

Note: If pixel shape is set as Line, Ellipse or Rectangle, two position points for each pixel are needed.

Example for Line: Set first position point (button 1. PNT) of pixel 1, than touch button 2.PNT and set the second position point of pixel 1. Press button Next and repeat this procedure for pixel 2, pixel 3 and pixel 4.



If you have connected e.g. five Footsies 2 TW, last pixel in the Pixel Setup procedure will be 20. At last pixel touch button Next

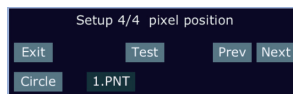

and the following screen will appear.

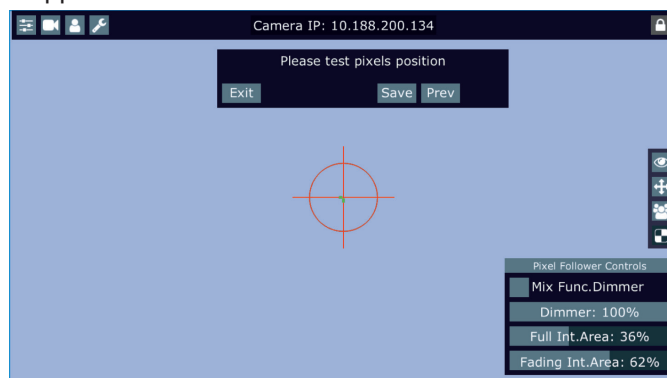

Check if all position points of pixels are correctly set by means of the button Prev and if it is OK, touch the button Save and Pixel Setup procedure is finished.

Menu "General Cfg." (General Configuration)

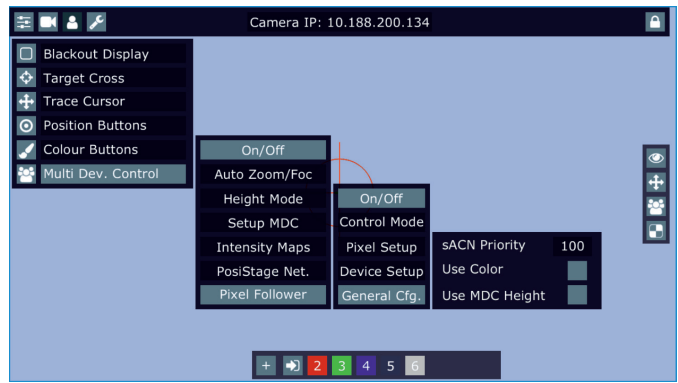

sACN Priority - the menu item allows you to set sACN priority (1-200). The highest number has the highest priority.

Use Color - if the option is active, colours from Colour buttons can be send to the active pixel of Footsie during MDC operation. Footsies have to be RGBW type for correct function of the option (e.g. red colour cannot be produced on Footsie 1 TW). The option does not influence colour of pixels in the Pixel Setup procedure.

Use MDC Height - the Pixel Follower system can work in three-dimensional space and this option allows you to use MDC height in the Pixel Follower operation.

Exaple for circle shape of pixel

MDC Height = ON

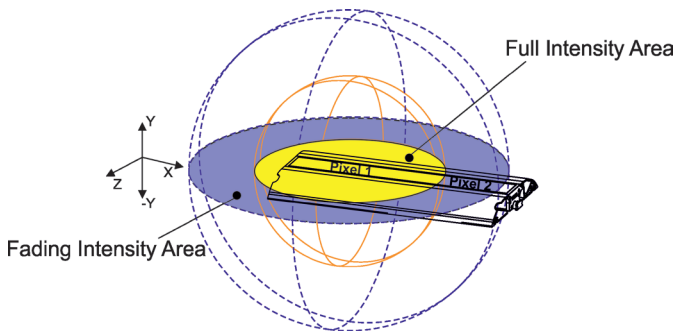

MDC Height = OFF

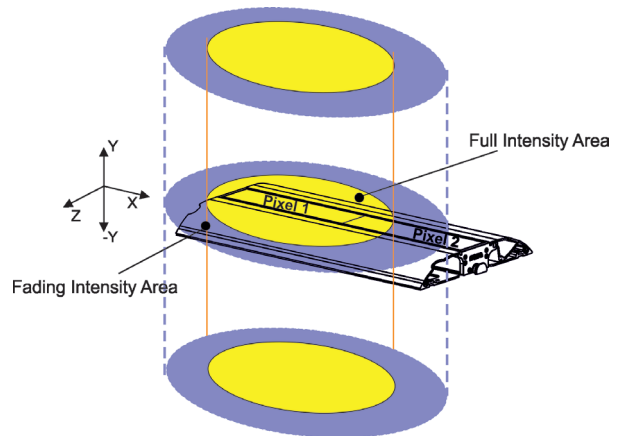

Menu "Control Mode".

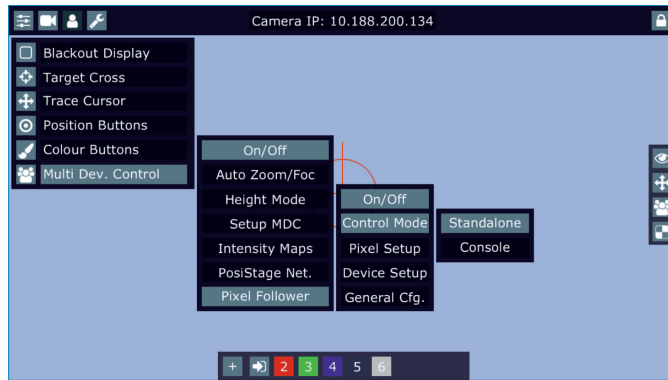

Standalone - mode suitable for situation when DMX console is not connected to the RoboSpot, the RoboSpot permanently sends 255 DMX on Shutter and Dimmer channels of Footsies. Brightness of pixels (zones) is controlled by means of the Pixel Follower Controls window.

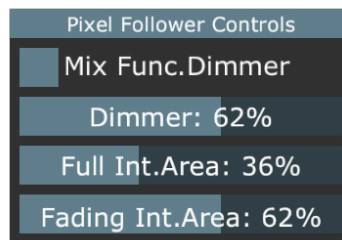

Console - mode suitable for situation when DMX console is connected to the RoboSpot. The Robospot sends on all Footsie channels 0 except the brightness channels of pixels (zones). If sACN priority set in the Pixel Follower (menu "General Cfg") and sACN priority set in DMX console are the same, the DMX console has to send 0 on brightness channels of pixels (zones) of Footsie to allow pixel intensity control by means of the Pixel Follower Controls window.

5.10 PosiStage Net

The menu option allows you to use a PosiStageNet protocol (an open protocol for on-stage, live 3D position data). Before activating the PosiStageNet protocol, the MDC setup has to be complete. The PosiStageNet protocol is active on both Ethernet connectors (Camera IN/Update, Ethernet) of the RoboSpot.

The item "On/Off" activates/deactivates the PosiStageNet protocol.

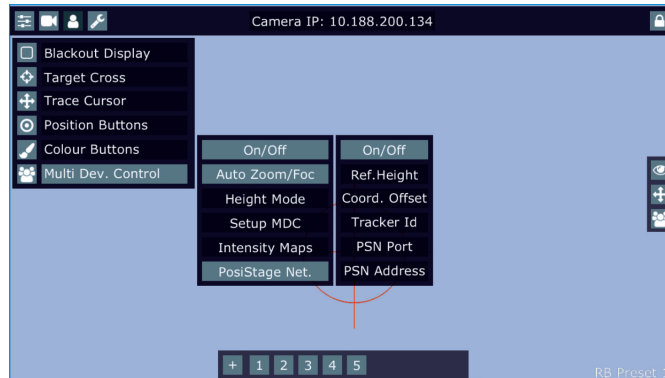

The item "Ref. Height" allows you to set a height (in mm) of a tilt axis of the reference fixture above the stage.

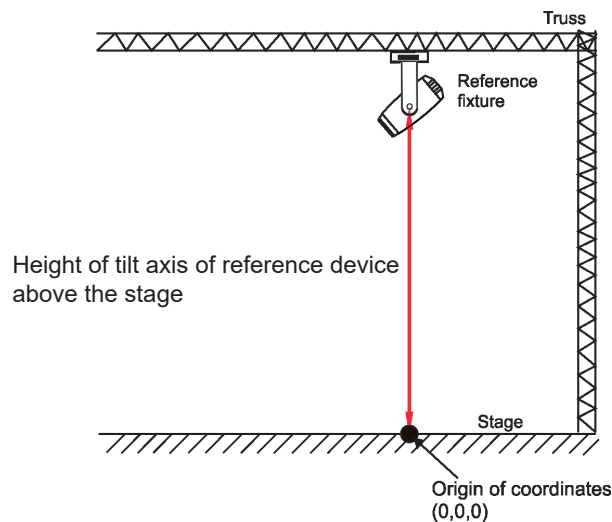

The item "Coord. Offset" enables other options relating to coordinates.

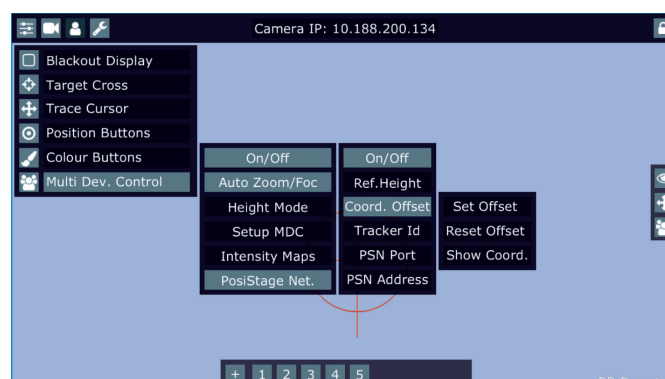

The item "Set Offset" allows you to set offset of the new origin of coordinates.

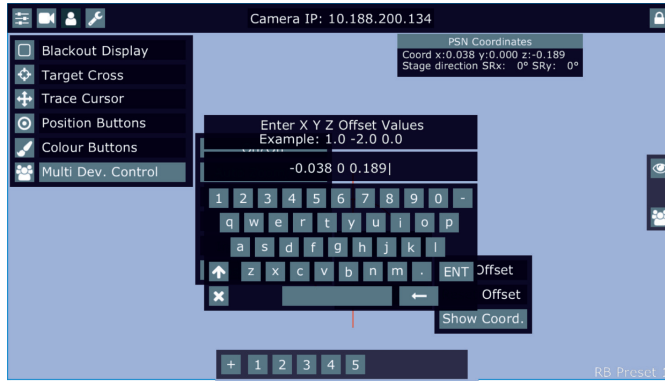

The values in the field XYZ offset (e.g. **-0.038 0 0.189**) have to be separated by a space.

The item "Show Coord." allows you to display PSN coordinates on the screen.

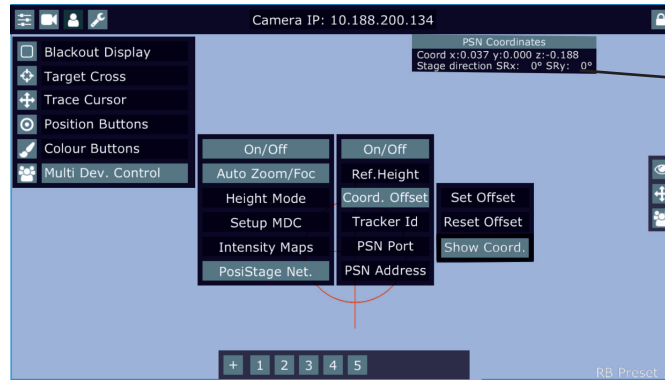

Stage direction SRx(SRy)-
virtual inclination of
the stage surface in x axis
(y axis).

Example: if you want to set origin of coordinates from point P0 to point P1, do the following steps:

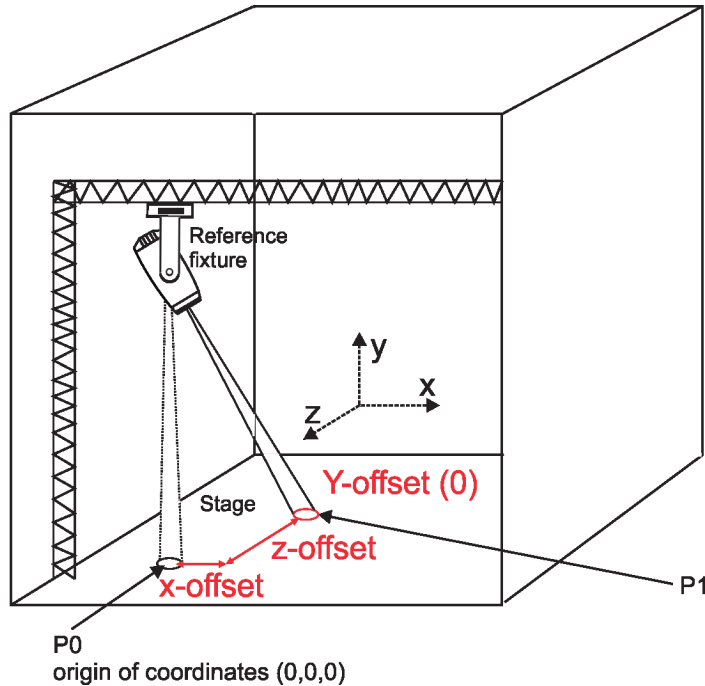

1. Use the option "Reset Offset" to reset existing offset.
2. Activate the option "Show Coord."

3. Aim the beam of reference fixture from point P0 to Point P1. Current coordinates of the point P1 will be displayed in the PSN Coordinates window.

Example:

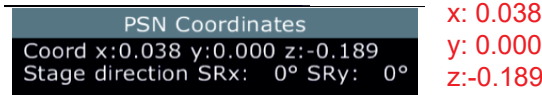

4. Select the option "Set Offset" and type the values from the PSN Coordinates window (with opposite signs) into the field XYZ Offset Values.

Example:

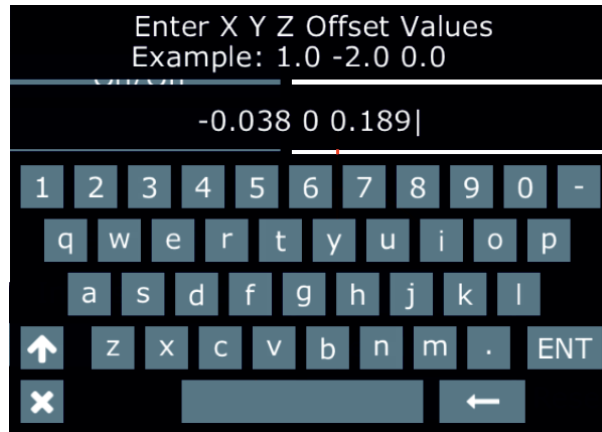

x:-0.038
y: 0.000
z: 0.189
Values xyz have to be separated by a space!

5. After pressing the ENT button, new origin of coordinates will be saved and the XYZ coordinates in the PSN Coordinates window will be set to 0.

Example:

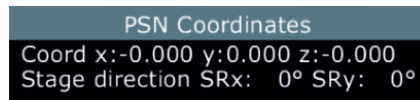

Last three items in the PosiStage Net menu allows you to set Tracker ID, PSN port and PSN Address.

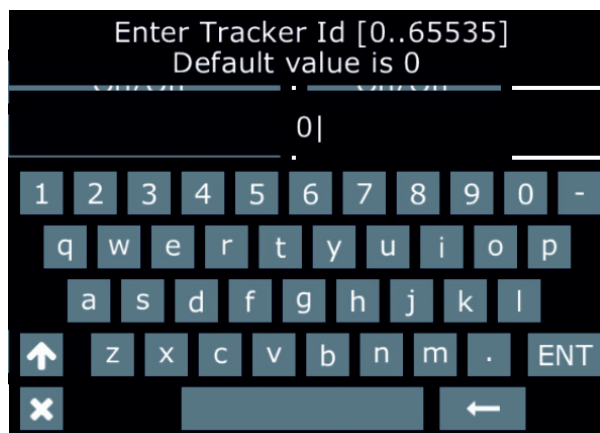

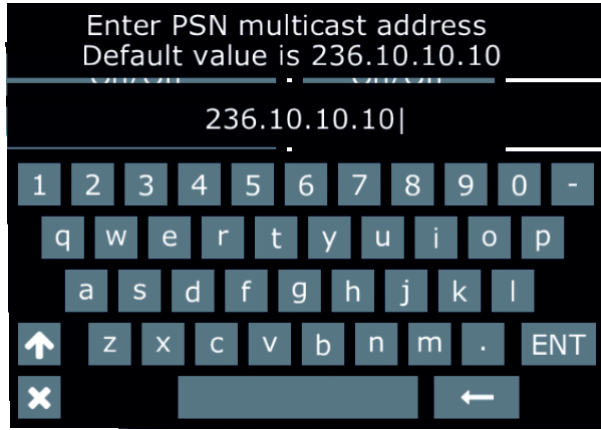

5.11 Ethernet based operation

Robe's implementation of sACN and RDM Net allows to use RoboSpot and supported Robe devices on Ethernet networks, without XLR based DMX. XLR DMX and sACN Output can also be combined, the DMX addressing space is one universe shared between XLR DMX and sACN Output, where some fixtures can be on DMX and some on sACN Output. DMX addresses of fixtures on XLR DMX must not collide with DMX addresses of fixtures on sACN Output.

Supported Robe fixtures: Robin BMFL Blade, Robin BMFL Spot, Robin Esprite, Robin Esprite Wash, Robin Forte, Robin Forte Wash, Robin iEsprite, Robin iForte, Robin iForte LTX, Robin iPainte, Robin Painte.

Discovery uses RDM Net, for DMX control sACN is used. Discovery grouping is done via RDM Net Broker Scope. Control grouping is done via sACN Universes.

Setting up.

- connect supported Robe fixtures and RoboSpot by Ethernet wiring. On the RoboSpot, use the Ethernet (RJ45) on the back panel.

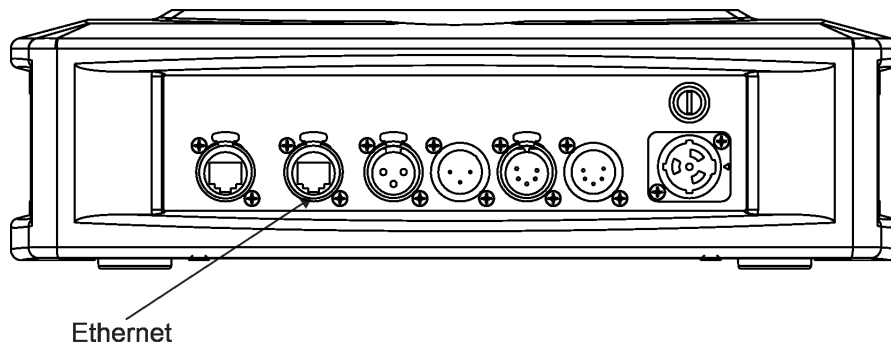

- in RoboSpot, set desired Broker Scope in menu Settings - RDMnet Broker Settings - Broker Scope.
- in RoboSpot, set desired output DMX sACN Universe in menu - Settings - Ethernet Output - Output sACN Universe.
- in fixtures, set Broker Scope (set the same scope as in RoboSpot) via REAP - Ethernet settings - Broker Scope.
- in fixtures, set DMX input to Ethernet, choose sACN protocol and set sACN Universe (set the same universe as in RoboSpot), this can be done display menu or via REAP (REAP= Robe Ethernet Access Portal).

Upon power up, discovered fixtures are available in RoboSpot. Devices discovered by the RoboSpot after the initial discovery can be added to RoboSpot without going through the full discovery again by using the Add Connected Devices in menu - Settings - RDM Discovery - Add Connected Devices.

To extend the length of the initial discovery time of the RoboSpot, use the menu - Settings - Discover Settings - Discovery Timeout.

Operational information.

It is recommended not to use the "default" as Broker Scope as devices newly added onto the network would be automatically added to RoboSpot even without an intent.

RDM Net connection operates on TCP layer, meaning fixtures and RoboSpots must be in the same network IP range to be able to communicate with each other.

You can combine XLR DMX and sACN Output to have some fixtures on XLR DMX and some on sACN Output, this is how for example Motion Camera can be utilized, as it does not have Ethernet DMX input.

If you use combination of a DMX console and a RoboSpot, it is simpler to use one sACN universe for signal from console to RoboSpot and another sACN universe from RoboSpot to fixtures. This setup doesn't require any sACN priority settings in the RoboSpot.

Showfile now contains also Ethernet IN/OUT settings and RDM Net Broker Scope to be able to switch complete configurations via showfile.

See examples of wiring and settings on the following pages.

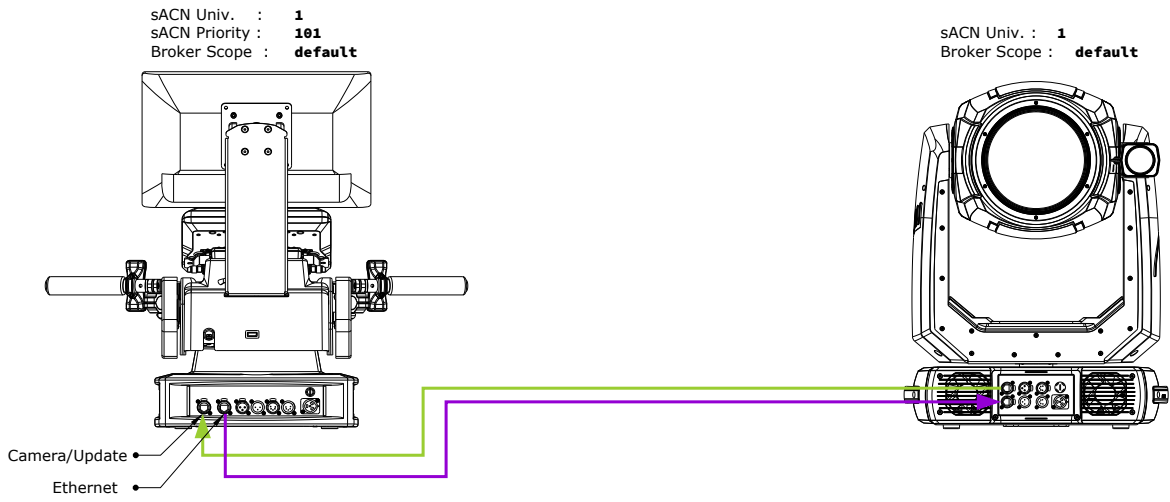

RoboSpot RDMNet Setup Simple - No Console

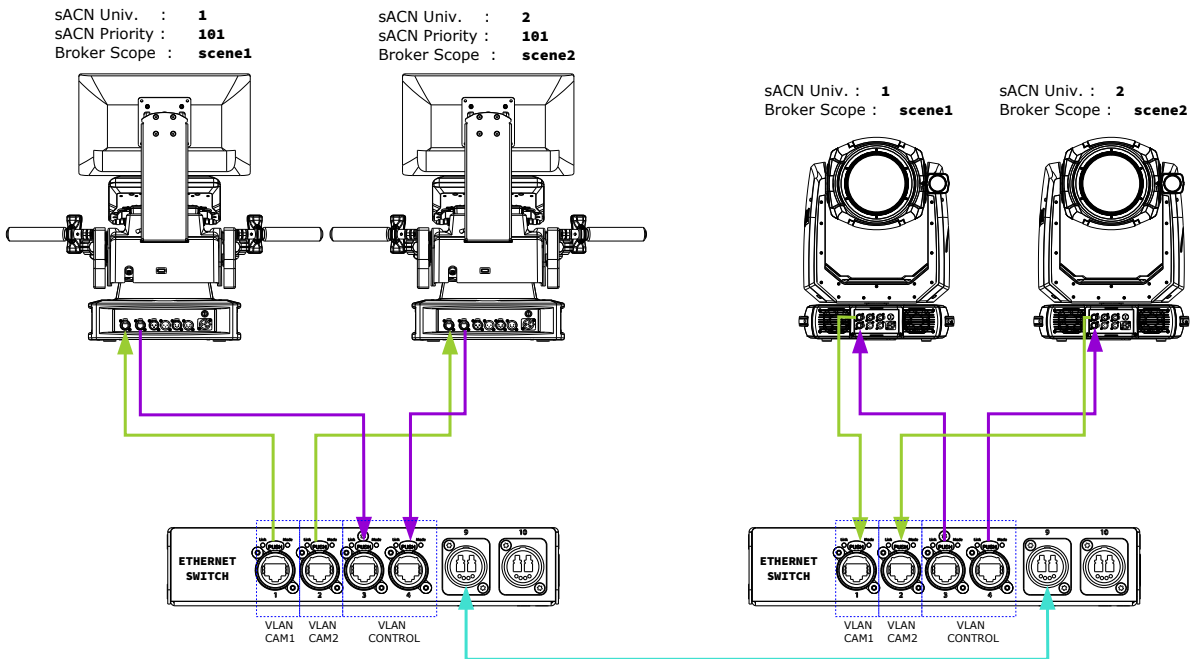
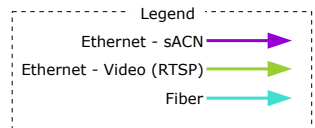

RoboSpot RDMNet Setup Simple - 2 Setups

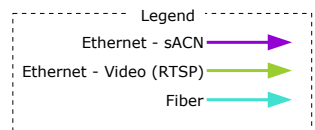

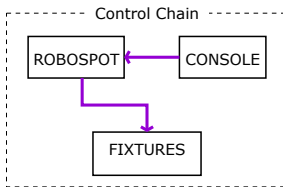
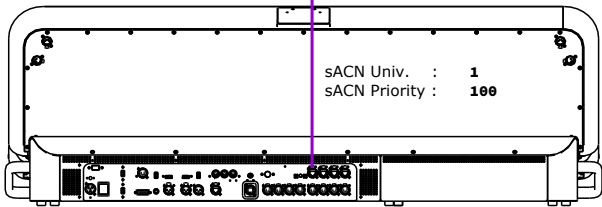
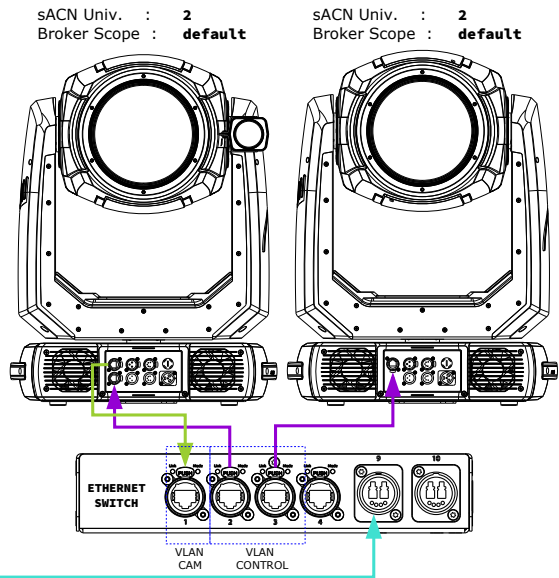
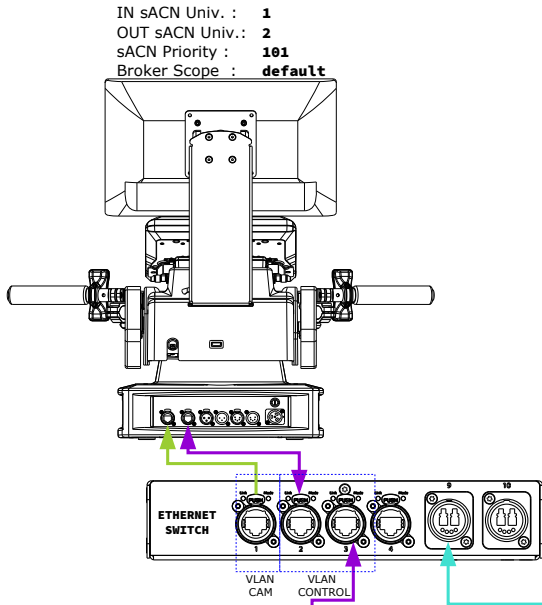

RoboSpot RDMNet Setup MDC - Console Control

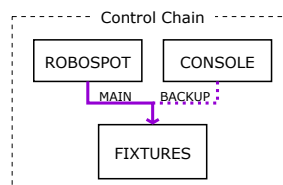
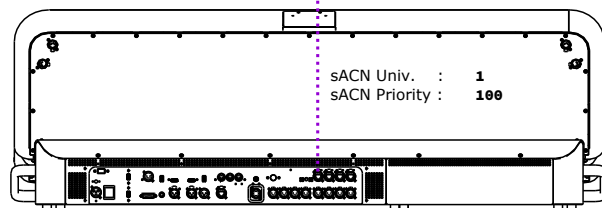
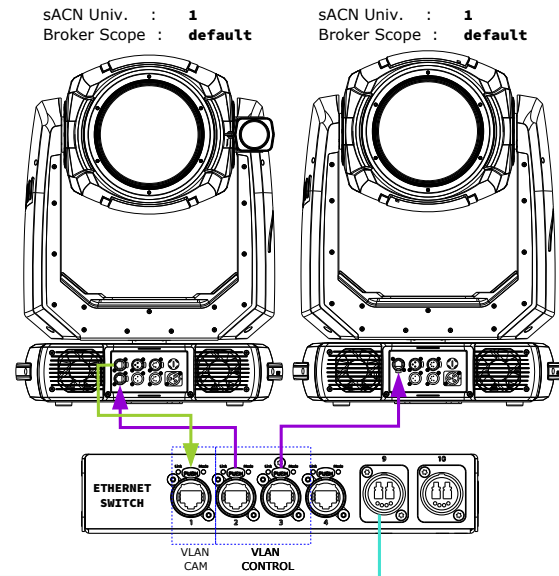
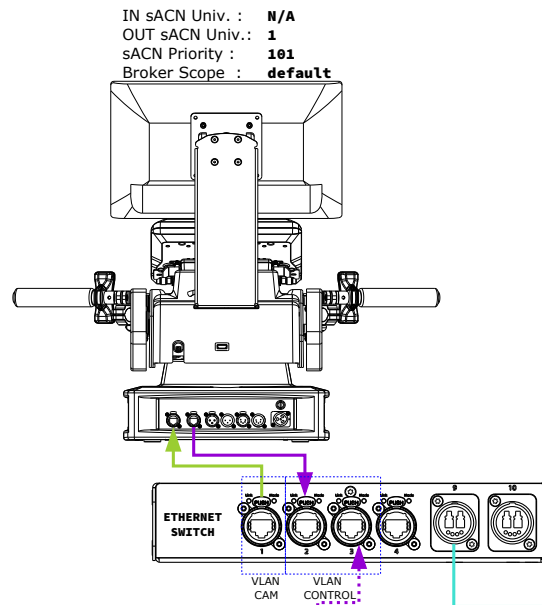
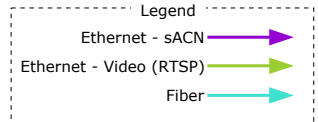

RoboSpot RDMNet Setup MDC - Console Backup

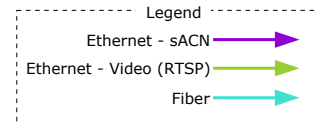





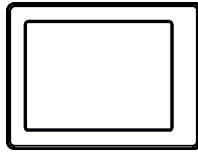

6. Control menu

The FollowSpot Controller is equipped with the QVGA Robe touch screen with battery backup which allows you to set the device behaviour according to your needs.



Icons used in the touch screen menu.

-  - [back arrow] used to move back to the previous screen (or menu level).
-  - [up arrow] used to move up on the previous page.
-  - [down arrow] used to move down on the next page.
-  - [confirm] used to save adjusted values and leave menu or to perform desired action.
-  - [cancel] used to leave menu without saving changes.
-  - [display on/off] used to switch on/off the display.
-  - [menu enter] used to enter fixture menu.

Note: buttons of control panel are not functional.

Touch the icon  to display the password entering screen:

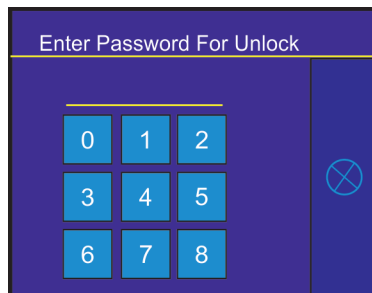

Enter the default password (5242) to enter the main menu of the FollowSpot Controller. The password prevents unauthorized person from changing setting of the FollowSpot Controller (password can be changed or switched off via the menu Settings).

Main menu

Page 1

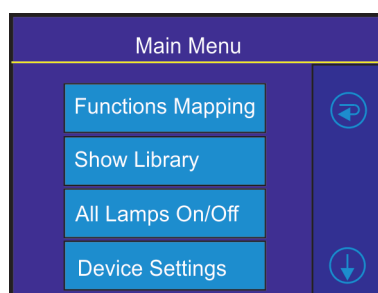

Page 2

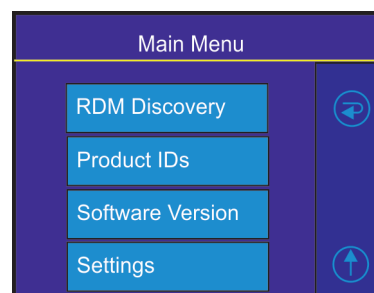

6.1 Functions Mapping

By entering the menu you can assign effects from the list of available effects to the jog-wheels and faders. List of available effect channels depends of the used moving head. The item **All** - releases all assigned effects at one go.

Note: The FollowSpot Controller does not allow to control full DMX range (0-255) of some effects, available DMX values for each effect are stated in the tables below.

The item "Heigh." (Height) is not stated in tables below and serves for Multi Devices Control.

Fixture	Effect	Available DMX values
Robin BMFL FollowSpot	Dimmer	0-255
	Iris	0-179
	Focus	0-255
	Zoom	0-255
	L Frost	0-254
	M Frost	0-254
	H Frost	0-254
	Color 1	0,130-189
	Color 2	0,130-189
	Cyan	0-255
	Magenta	0-255
	Yellow	0-255
	CTO	0-255

Fixture	Effect	Available DMX values
Robin BMFL Spot	Dimmer	0-255
	Iris	0-179
	Focus	0-255
	Zoom	0-255
	L Frost	0,1-50
	M Frost	0,87-136
	H Frost	0,173-222
	Color 1	0,130-189
	Color 2	0,130-189
	Cyan	0-255
	Magenta	0-255
	Yellow	0-255
	CTO	0-255
	DgW. pos	0-127
	DgW. r1	0-255
	DgW. r2	0-255
	RGW 1	0,32-59
	RGWr 1	0-255
	RGW 2	0,32-59
	RGWr 2	0-255
Prism	0-127	
Pris r	0-255	

Fixture	Effect	Available DMX values
Robin BMFL Blade	Dimmer	0-255
	Iris	0-179
	Focus	0-255
	Zoom	0-255
	L Frost	0,1-50
	M Frost	0,87-136
	H Frost	0,173-222
	Color 1	0,130-189
	Color 2	0,130-189
	Cyan	0-255
	Magenta	0-255
	Yellow	0-255
	CTO	0-255
	Efw. pos	0-127
	Efw. rot	0-255
	SGW	0, 8-103
	RGW 1	0,32-59
	RGW r1	0-255
	Prism	0-127
	Pris r	0-255
	FS rot	0-255
	FS 1 m	0-255
	FS 1 s	0-255
	FS 2 m	0-255
	FS 2 s	0-255
	FS 3 m	0-255
	FS 3 s	0-255
	FS 4 m	0-255
FS 4 s	0-255	

Fixture	Effect	Available DMX values
Robin BMFL WashBeam	Dimmer	0-255
	Iris	0-179
	Focus	0-255
	Zoom	0-255
	L Frost	0-254
	M Frost	0-254
	H Frost	0-254
	Color 1	0,130-189
	Color 2	0,130-189
	Cyan	0-255
	Magenta	0-255
	Yellow	0-255
	CTO	0-255
	Efw. pos	0-127
	Efw. rot	0-255

Fixture	Effect	Available DMX values
Robin BMFL WashBeam	RGW 1	0,32-59
	RGWr 1	0-255
	FS rot	0-255
	FS 1 m	0-255
	FS 1 s	0-255
	FS 2 m	0-255
	FS 2 s	0-255
	FS 3 m	0-255
	FS 3 s	0-255
	FS 4 m	0-255
	FS 4 s	0-255

Fixture	Effect	Available DMX values
Robin DL7S	Dimmer	0-255
	Iris	0-179
	Focus	0-255
	Zoom	0-255
	Frost	0-179
	V Colour	0-132
	Cyan	0-255
	Magenta	0-255
	Yellow	0-255
	Red	0-255
	Green	0-255
	Blue	0-255
	Amber	0-255
	C Blue	0-255
	L Green	0-255
	CTO	0-255
	Efw. pos	0-127
	Efw. rot	0-255
	SGW	0, 65-109
	RGW	0, 32-59
	RGW r	0-255
	Prism	0-127
	Pris r	0-255
	FS rot	0-255
	FS 1 m	0-255
	FS 1 s	0-255
	FS 2 m	0-255
	FS 2 s	0-255
	FS 3 m	0-255
	FS 3 s	0-255
FS 4 m	0-255	
FS 4 s	0-255	

Fixture	Effect	Available DMX values
Robin DL4S	Dimmer	0-255
	Iris	0-179
	Focus	0-255
	Zoom	0-255
	Frost	0-179
	V Color	0-247
	Red	0-255
	Green	0-255
	Blue	0-255
	White	0-255
	CTO	0-255
	Efw. pos	0-127
	Efw. rot	0-255
	RGW	0, 32-59
	RGW r	0-255
	Prism	0-127
	Pris r	0-255
	FS rot	0-255
	FS 1 m	0-255
	FS 1 s	0-255
	FS 2 m	0-255
	FS 2 s	0-255
	FS 3 m	0-255
	FS 3 s	0-255
FS 4 m	0-255	
FS 4 s	0-255	

Fixture	Effect	Available DMX values
Robin Pointe	Dimmer	0-255
	Focus	0-255
	Zoom	0-255
	Frost	0-189
	Color 1	0, 130-189
	SGW	0, 4-87
	RGW	0, 32-59
	RGW r	0-255
	Prism	0-127
	Pris r	0-255

Fixture	Effect	Available DMX values
Robin MegaPointe Robin iPointe Robin iPointe65	Dimmer	0-255
	Focus	0-255
	Zoom	0-255
	Frost	0-50, 87-136, 173-222
	Cyan	0-255
	Magenta	0-255
	Yellow	0-255

Fixture	Effect	Available DMX values
Robin MegaPointe Robin iPointe Robin iPointe65	Color 1	0, 130-189
	V Color	0-132
	Efw. pos	0-127
	Efw. rot	0-255
	SGW	0, 4-87
	RGW 1	0, 32-59
	RGWr 1	0-255
	Prism 1	0-27
	Pris1 r	0-255
	Prism 2	0-27
	Pris2 r	0-255
	Beam	0-19
	Beam r	0-255

Fixture	Effect	Available DMX values
Robin T1 Profile Robin T1 Profile FS	Dimmer	0-255
	Iris	0-179
	Focus	0-255
	Zoom	0-255
	Frost	0-50, 87-136, 173-222
	V Color	0-132
	Red	0-255
	Green	0-255
	Blue	0-255
	Amber	0-255
	L Green	0-255
	CTO	0-255
	Efw. pos	0-127
	Efw. rot	0-255
	RGW 1	0, 32-59
	RGWr 1	0-255
	Prism	0-127
	Pris r	0-255
	FS rot	0-255
	FS 1 m	0-255
	FS 1 s	0-255
	FS 2 m	0-255
	FS 2 s	0-255
	FS 3 m	0-255
	FS 3 s	0-255
	FS 4 m	0-255
	FS 4 s	0-255

Fixture	Effect	Available DMX values
Robin Spiider Robin iSpiider Robin Tarrantula	Dimmer	0-255
	Red	0-255
	Green	0-255
	Blue	0-255
	White	0-255
	CTO	0-255
	Zoom	0-255
	A. Zone	0-72

Fixture	Effect	Available DMX values
Robin LedBeam 150 Robin LedBeam 350 Robin iBeam 350	Dimmer	0-255
	Red	0-255
	Green	0-255
	Blue	0-255
	White	0-255
	CTO	0-255
	Zoom	0-255

Fixture	Effect	Available DMX values
Robin Viva CMY Robin SilverScan	Dimmer	0-255
	Color 1	0, 130-189
	Cyan	0-255
	Magenta	0-255
	Yellow	0-255
	SGW	0, 9-91
	RGW 1	0, 32-59
	RGWr 1	0-255
	Prism	0-127
	Pris r	0-255
	Frost	0-179
	Iris	0-179
	Zoom	0-255
	Focus	0-255

Fixture	Effect	Available DMX values
Robin Esprite Robin Esprite FS Robin iEsprite Robin iEsprite FS	Dimmer	0-255
	Iris	0-179
	Focus	0-255
	Zoom	0-255
	L Frost	0, 1-50
	M Frost	0, 87-136
	H Frost	0,173-222
	Color 1	0,130-189
	Color 2	0,130-189
	Cyan	0-255
	Magenta	0-255
	Yellow	0-255
	CTO	0-255
	Efw. pos	0-127
	Efw. rot	0-255
	SGW	0, 9-91
	RGW 1	0,32-59
	RGW r1	0-255
	Prism	0-127
	Pris r	0-255
	FS rot	0-255
	FS 1 m	0-255
	FS 1 s	0-255
	FS 2 m	0-255
	FS 2 s	0-255
	FS 3 m	0-255
	FS 3 s	0-255
	FS 4 m	0-255
FS 4 s	0-255	

Fixture	Effect	Available DMX values
Robin MMX WashBeam	Dimmer	0-255
	Focus	0-255
	Zoom	0-255
	Color 1	0,130-189
	Cyan	0-255
	Magenta	0-255
	Yellow	0-255
	CTO	0-255
	RGW 1	0,32-59
	RGWr 1	0-255
	FS rot	0-255
	FS 1 m	0-255
	FS 2 m	0-255
	FS 3 m	0-255
	FS 4 m	0-255
	Hot S.	0-255

Fixture	Effect	Available DMX values
Robin MMX Blade	Dimmer	0-255
	Focus	0-255
	Zoom	0-255
	Color 1	0,130-189
	Cyan	0-255
	Magenta	0-255
	Yellow	0-255
	CTO	0-255
	Efw. pos	0-127
	Efw. rot	0-127
	RGW 1	0,32-59
	RGWr 1	0-255
	Prism	0-127
	Pris r	0-255
	Frost	0-179
	Iris	0-179
	FS rot	0-255
	FS 1 m	0-255
	FS 2 m	0-255
	FS 3 m	0-255
	FS 4 m	0-255
	Hot S.	0-255

Fixture	Effect	Available DMX values
Robin T2 Profile	Dimmer	0-255
	Iris	0-179
	Focus	0-255
	Zoom	0-255
	Frost	0-50, 87-136, 173-222
	V Color	0-132
	Red	0-255
	Green	0-255
	Blue	0-255
	Amber	0-255
	L Green	0-255
	CTO	0-255
	Efw. pos	0-127
	Efw. rot	0-255
	SGV	0, 8-103
	RGW 1	0, 32-59
	RGWr 1	0-255
	Prism1	0-127
	Pris1 r	0-255
	Prism2	0-127
	Pris1 2	0-255
	FS rot	0-255
	FS 1 m	0-255
	FS 1 s	0-255
	FS 2 m	0-255

Fixture	Effect	Available DMX values
Robin T2 Profile	FS 2 s	0-255
	FS 3 m	0-255
	FS 3 s	0-255
	FS 4 m	0-255
	FS 4 s	0-255

Fixture	Effect	Available DMX values
Robin Forte Robin Forte FS Robin iForte Robin iForte FS	Dimmer	0-255
	Iris	0-179
	Focus	0-255
	Zoom	0-255
	Frost	0-50, 87-136
	Color 1	0,130-189
	Color 2	0,130-189
	Cyan	0-255
	Magenta	0-255
	Yellow	0-255
	CTO	0-255
	Efw. pos	0-127
	Efw. rot	0-255
	RGW 1	0,32-59
	RGW r1	0-255
	RGW 2	0,32-59
	RGW r2	0-255
	Prism 1	0-127
	Pris1 r	0-255
	Prism 2	0-127
	Pris2 r	0-255
	FS rot	0-255
	FS 1 m	0-255
	FS 1 s	0-255
	FS 2 m	0-255
	FS 2 s	0-255
	FS 3 m	0-255
	FS 3 s	0-255
	FS 4 m	0-255
	FS 4 s	0-255

Fixture	Effect	Available DMX values
Robin Cuete	Dimmer	0-255
	Focus	0-255
	Frost	0-179
	Color	0,130-189
	Cyan	0-255
	Magenta	0-255
	Yellow	0-255
	SGW	0,10-89
	RGW	0,32-59
	RGW r	0-255
	Prism	0-127
	Pris r	0-255
	Power	225-239

Fixture	Effect	Available DMX values
Robin Spote	Dimmer	0-255
	Focus	0-255
	Frost	0-179
	Color	0,130-189
	Cyan	0-255
	Magenta	0-255
	Yellow	0-255
	RGW	0,32-59
	RGW r	0-255
	Prism	0-127
	Pris r	0-255
	Power	225-239

Fixture	Effect	Available DMX values
Robin Promotion	Zoom	0-255
	Focus	0-255
	Key V (Keystoning vertical)	0-255
	Key H (Keystoning horizontal)	0-255
	Cyan	0-255
	Magenta	0-255
	Yellow	0-255
	Col Ew (Colour effect wheel)	0-175
	GW sel (Digital gob wheel selection)	0-127
	RGW 1 (Digital gobo wheel)	0-255
	RGWr 1 (Digital gobo indexing and rotation)	0-255
	Efw. pos (Effect wheel)	0-48, 80-89, 100-108, 180-195
	GB cor (grey box correction)	0-255
	Strobe	16-127
	Dimmer	0-255

Fixture	Effect	Available DMX values
Robin Painte Robin iPainte	Dimmer	0-255
	Focus	0-255
	Frost	0-179
	Color	0,130-189
	Cyan	0-255
	Magenta	0-255
	Yellow	0-255
	V Color	0-132
	CTO	0-255
	SGW	0,9-91
	RGW	0,42-73
	RGW r	0-255
	Prism	0-127
	Pris r	0-255
	Frost	0-179
	Iris	0-179
	FS rot	0-255
	FS 1 m	0-255
	FS 1 s	0-255
	FS 2 m	0-255
	FS 2 s	0-255
	FS 3 m	0-255
	FS 3 s	0-255
	FS 4 m	0-255
	FS 4 s	0-255
	Power	225-239

Fixture	Effect	Available DMX values
Robin BMFL WashBeam EV	Dimmer	0-255
	Iris	0-179
	Focus	0-255
	Zoom	0-255
	L Frost	0-254
	M Frost	0-254
	H Frost	0-254
	V Color	0-132
	Color 1	0,130-189
	Color 2	0,130-189
	Cyan	0-255
	Magenta	0-255
	Yellow	0-255
	CTO	0-255
	RGW 1	0,32-59
	RGWr 1	0-255
	RGW 2	0,32-59
	RGWr 2	0-255
	FS rot	0-255

Fixture	Effect	Available DMX values
Robin BMFL WashBeam EV	FS 1 m	0-255
	FS 1 s	0-255
	FS 2 m	0-255
	FS 2 s	0-255
	FS 3 m	0-255
	FS 3 s	0-255
	FS 4 m	0-255
	FS 4 s	0-255

Fixture	Effect	Available DMX values
Robin T1 Profile Robin T1 Profile FS	Dimmer	0-255
	Iris	0-179
	Focus	0-255
	Zoom	0-255
	Frost	0-50, 87-136, 173-222
	V Color	0-132
	Red	0-255
	Green	0-255
	Blue	0-255
	Amber	0-255
	L Green	0-255
	CTO	0-255
	Efw. pos	0-127
	Efw. rot	0-255
	SGV	0, 9-91
	RGW 1	0, 32-59
	RGWr 1	0-255
	FS rot	0-255
	FS 1 m	0-255
	FS 1 s	0-255
	FS 2 m	0-255
	FS 2 s	0-255
	FS 3 m	0-255
	FS 3 s	0-255
FS 4 m	0-255	
FS 4 s	0-255	

Fixture	Effect	Available DMX values
Robin iForte LTX WB Robin iForte LTX FS	Power	90-93
	Dimmer	0-255
	Iris	0-179
	Focus	0-255
	Zoom	0-255
	Frost	0-50, 87-136
	Color 1	0,130-189
	Color 2	0,130-189
	Cyan	0-255

Fixture	Effect	Available DMX values
Robin iForte LTX WB Robin iForte LTX FS	Magenta	0-255
	Yellow	0-255
	CTO	0-255
	V Color	0-132
	Efw1. pos	0-127
	Efw1. rot	0-255
	Efw2. pos	0-127
	Efw2. rot	0-255
	RGW 1	0,32-59
	RGW r1	0-255
	Prism 1	0-127
	Pris1 r	0-255
	Prism 2	0-127
	Pris2 r	0-255
	Frost	0-50, 87-136
	FS rot	0-255
	FS 1 m	0-255
	FS 1 s	0-255
	FS 2 m	0-255
	FS 2 s	0-255
	FS 3 m	0-255
	FS 3 s	0-255
	FS 4 m	0-255
FS 4 s	0-255	

6.2 Show Library

Select/Rename Show - the menu item offers 10 shows. In the show is saved setting of the RoboSpot system:

- Functions mapping
- FollowSpot Controller presets
- Sensitivity of jog-wheels
- Faders switching and inversion
- Position buttons
- DMX addresses and modes of connected devices
- RDM information about connected devices (only if the option "Manual" is selected in the menu "Discovery Settings")
- Ethernet IN/OUT settings
- RDM Net Broker Scope

Note: values in the menu Ethernet settings (menu Settings) are not saved to the show.
The show can be saved on a USB flash drive and loaded back to the RoboSpot .

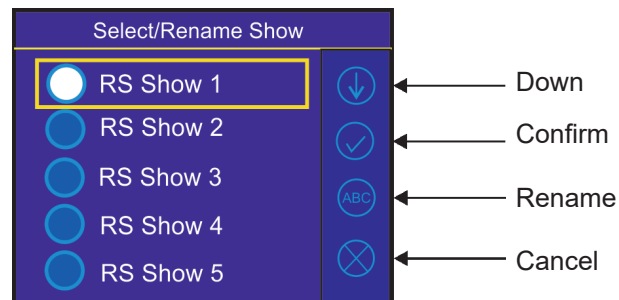

To select a show.

Select desired show by touching its button and confirm it. The notice: "Switch To Show OK" will appear for a moment on the screen.

Selected show is displayed in the bottom right corner of the LCD screen.

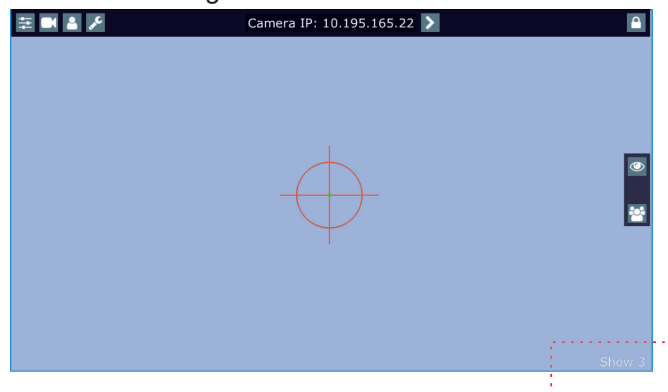

Error and notice messages:

"Already In selected Show"- it means that you are trying to switch to active show .

"Switch To Show Error" - it means that some problem in desired show file occurred.

All changes in setting of the RoboSpot made by the user are immediately saved into the selected show.

To rename a show.

1. Select desired show by touching its button.
2. Touch the Rename icon. The virtual keyboard will appear on the LCD screen with selected show, e.g. Show 3.
3. Now you can edit the name of the show and confirm it by the key ENT.

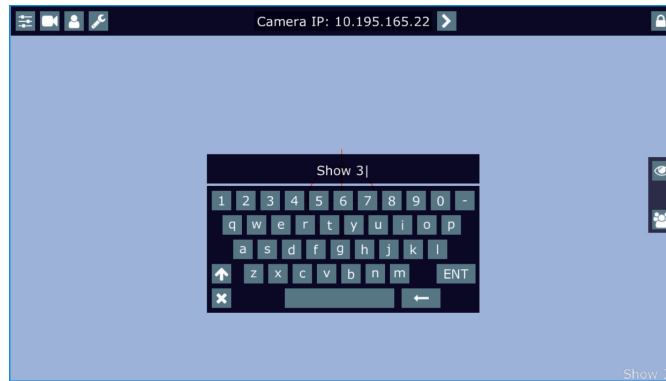

Export Show - the menu item allows you to save a show on a USB flash drive connected to the USB port of the RoboSpot. Supported file systems of the USB flash drive are: FAT16, FAT32, EXT2, EXT3, EXT4.



To export a show.

1. Connect a USB flash drive to the USB port marked USB 50mA.
2. Select desired show (e.g. Show 3) and confirm it.
3. The virtual keyboard will appear on the screen with a name of the show file. You can edit the name of the show and confirm it by the key ENT. The show file on the USB flash drive will have extension rsl (e.g. RSShowLibrary-03.rsl).

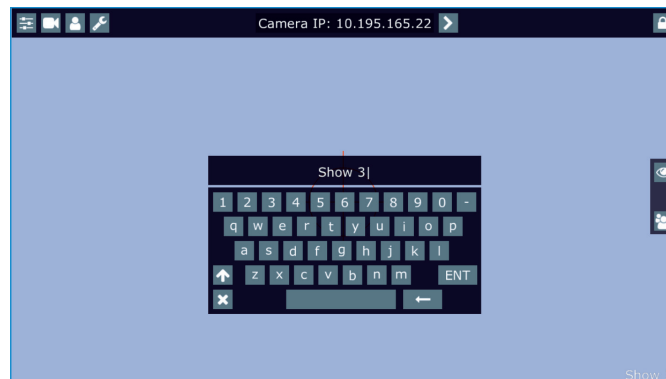

If the import is successful, the notice: "Export Show OK" will appear for a moment on the screen.

Error and notice messages:

- "Export Show Error ID:" - it means that the show library export failed. If ID=-1, it means that show file cannot be saved on the USB flash drive(e.g. the USB flash drive is set read-only)
- "USB flash drive is not present "- it means that the USB flash drive is not connected to the USB port of the RoboSpot.

Import Show - the menu item allows you to load a show file saved on a USB flash drive connected to the USB port of the RoboSpot.

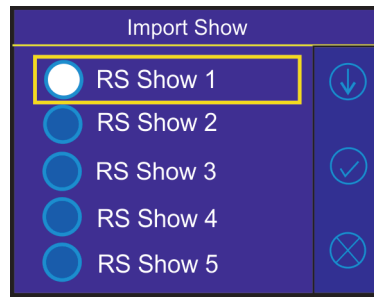

To import a show.

1. Connect a USB flash drive to the USB port marked USB 50mA.
2. Select a show (e.g. Show 1) to which you want to load a show file from the USB flash drive and confirm it.
3. The list of available show files on the USB flash drive will appear on the LCD screen e.g.



4. Select desired show file (e.g. Show 6.rsl) and touch the button "Import" to load selected show file to the RoboSpot. If the import is successful, the notice: "Import Show OK" will appear. You can also delete selected show from the USB flash drive by means of the option "Delete".

Error and notice messages:

- "No show files on USB flash drive" - it means that no show file was found on the USB flash drive.
- " Import Show Error! " it means that some problem has occurred during writing of show file to the internal memory drive of the RoboSpot
- "USB flash drive is not present " - it means that the USB flash drive is not connected to the USB port of the RoboSpot.
- " Err: Cannot find show file " - it means that the show file cannot be loaded from the USB flash drive.
- " Err: Wrong version of show file" - it means that the show file has a wrong format.

Note. You can load to selected show any show file, for example, to the show 10 you can load the file RShowLibrary-02.rsl. Original show file in the show 10 will be overwritten.

New Show - the menu item allows you to create a new show.

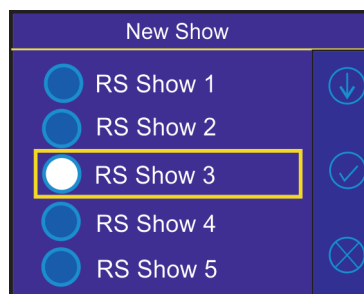

Select a show (e.g. RS Show 3) in which you want to create the new show and confirm it. Original show (saved in RS Show 3) will be deleted.

6.3 All Lamps On/Off

The menu item allows you to switch on/off lamp in the Robin BMFL FollowSpot and fixtures connected to this Robin BMFL FollowSpot.

6.4 Devices Settings

Note: Some fixture has to be connected to the Robospot in order to display the menu item. By entering the menu, list of available devices will be displayed, e.g.

BMFL Follow Spot: 033 (Robin BMFL Follow Spot)

RoboCamera: 001 (RoboSpot MotionCamera)

Touch desired device and the following menu items will appear.

Set Device Label - the menu item allows you to rename actual device. Touch the item until the keyboard will appear on the touch screen. Use the key <-- to delete original name of the device and type a new name. Confirm it by means of the key ENT.

Pan Offset - allows you to set a pan offset in the range of +/-100% .

Tilt Offset - allows you to set a tilt offset in the range of +/-100%.

Zoom Offset - allows you to set a zoom offset in the range of +/-100%.

Focus Offset - allows you to set a focus offset in the range of +/-100%.

Lamp On/Off - allows you to switch on/off lamp of the device

Pan/Tilt reverse - allows you to reverse the pan/tilt movement of the device.

DMX Address - allows you to set DMX address of the device.

DMX Preset - allows you to select DMX mode of the device.

Device Default Settings - sets all items stated above (except DMX Address and DMX Preset) to the default (factory) values.

Set To Def. In Preset - sets items of devices displayed in the menu "Devices Settings" to default values. This function affects the active user preset only.

Set All To Defaults - sets items of devices displayed in the menu "Devices Settings" to default values. This function affects all user presets.

6.4 RDM Discovery

RDM Discovery

The menu item serves for searching devices and should be used when you connect/disconnect some fixture to the RoboSpot. The behaviour of the function depends on setting the item "Discovery Settings" (menu Settings). If the item "Discovery Settings" is set to Auto, no message appears after finishing this procedure.

If the item "Discovery Settings" is set to Manual, the following message will appear:

Do You Want To Save
Discovery Config
To RoboSpot Base

If you confirm it, the list of discovered fixtures will be saved and at every switching the RoboSpot on, fixtures from the list will be loaded to the RoboSpot without discovery procedure running at the RoboSpot starting-up. If the item "Discovery Settings" is set to Auto and no device is connected to the RoboSpot, the graphic touch screen of the Follow Spot Controller displays message "Waiting for devices". To terminate the message and enter the menu, touch this graphic touch screen for 6 seconds until you get into menu screen.

In case that some fixtures connected to the RoboSpot are on the same DMX address or have overlapping channels, the following message will appear:

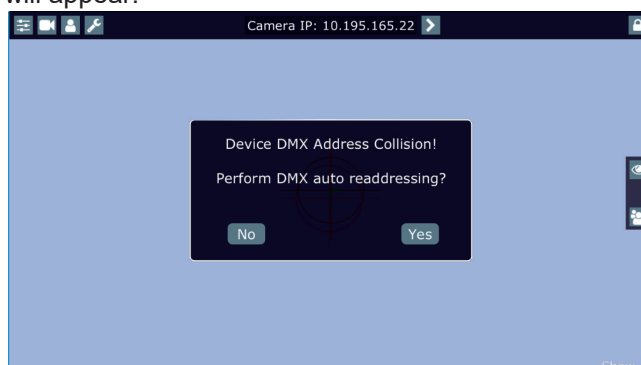

If you select option the Yes, collision fixtures will be automatically readdressed.
If you select No, DMX addresses will stay without change.

Add Connected Devices

The menu item serves for discovery newly connected fixtures if the procedure "RDM Discovery" has already run. The procedure "Add Connected Devices" is much faster than procedure "RDM Discovery".

6.5 DMX In/Out

After entering the menu item all channels from a current DMX universe are displayed and can be browsed by touching the keys UP/DOWN. DMX value for every channel is displayed in the table.

	Channel 1	Channel 2	Channel 3
Example:	+0	+1	+2
1	000	000	000
4	000	000	000
7	000	000	000

In case that value coming via Ethernet and value going to fixtures (e.g. Robin BMFL FollowSpot) are not the same at certain channel, both values are displayed in the following order: value from Ethernet/ value to the fixture (e.g. 190/120).

6.6 Product IDs

Select this menu item to read MAC Address, RDM UID and RDM Broker Scope/Port.

6.7 Network Info

The menu provides network information.

Example:

IP Address
2.242.0.170
Net Mask
255.0.0.0
RDMnet Broker Scope/Port
default/5253
RDMnet Broker Clients
8
Wired/RDMNet Devices Count
4/8
sACN Input Universe
1
RDMNet sACN Output
Universe 2/Priority 101

6.8 Software Version

Select this item to read the software version of the fixture modules:

Display System - a display processor

Module C - a control panel processor

Module RPI - a control computer in the fixture base

6.9 Settings

The menu allows you to set the behaviour of the RoboSpot according to your needs.

System Test - the menu allows you to test jog-wheels, faders and pan/tilt movement of the RoboSpot.

Ethernet Settings - the menu allows you to set the RoboSpot for the Ethernet operation

Ethernet Mode

- Artnet** - Fixture receives Artnet protocol
- gMAI** - Fixture receives MANet I protocol
- gMA2** - Fixture receives MANet 2 protocol
- sACN** - Fixture receives sACN protocol

Ethernet Output

Output sACN Universe - The menu item allows you to set desired sACN universe. Range is 1-32000, default value is OFF

Output sACN Priority - The menu item allows you to set desired sACN priority. Range is 0-200, default value is 101.

Output sACN DMX is the same as XLR Output DMX.

IP Address/Net Mask - select this menu to set IP address. IP address is the Internet protocol address. The IP uniquely identifies any node (fixture) on a network.

There cannot be 2 fixtures with the same IP address on the network!

Default IP Address - Preset IP address, you can set up only first byte of IP address (2 or 10) e.g. **002.019.052.086**.

Custom IP Address - The option enables to set up all bytes of IP address.

Net Mask - The option enables to set up all bytes of Net Mask.

ArtNet Universe - use this item to set a Universe (0-255). The Universe is a single DMX 512 frame of 512 channels.

MANet Settings - use this menu to set parameters for MANet operation.

MANet Universe I/II - The value of this item can be set in range 1-256.

MANet Session ID - The value of this item can be set in range 1-32.

sACN Universe - The item allows you to set input sACN universe (range 1-32000).

RDMnet Broker Settings

Broker Scope - The scope for the broker service on this device. After entering the menu item, the following notice will appear on the screen:

"Type Broker Scope on the touch screen "

Type scope on the monitor screen (can be up to 16 characters long). Default string is "default".

Make sure that you set the same Broker Scope in the fixtures you would like to be connected to this particular RoboSpot. The Broker Scope in fixtures can be set via Robe Ethernet Access Portal (REAP) web interface.

Broker Port - The port on which the broker service is run. Default value is 5253.

Discovery Settings - the menu item allows you to set a behaviour of the RoboSpot during RDM discovery process (menu item RDM Discovery) and after switching the RoboSpot on.

Discovery Mode

Auto - the RoboSpot searches connected devices after each switching it on and does not save the list of discovered devices. Also If the option RDM Discovery is run, the list of discovered devices is not saved.

Manual - the RoboSpot searches connected devices and save the list of discovered devices.

When the RoboSpot is switched on, the saved list of discovered devices will be load to the RoboSpot and (even in case that fixtures are not be connected to RoboSpot) the RoboSpot will not run the discovery procedure.

Discovery Timeout - the menu item allows you to set timeout in range of 1-21 seconds.

E.g. if Timeout=6 seconds, the RoboSpot will wait 6 seconds after discovering all fixtures to completely finish discovery process.

Controls invert - the menu item allows you to invert pan/tilt and faders of the RoboSpot. Default settings of faders: fader down-minimum (0 DMX), fader up-maximum (255 DMX).

Faders Switch - swaps functions of faders.

Camera Rotation - the function rotates a camera picture on the monitor 180 degrees from the current orientation.

Camera Zoom invert - the function inverts a value goes from a camera zoom control element (Jog wheel or slider) to the camera.

Shutter Pass On - the function has influence on behaviour of shutters of connected fixtures.

Off - After switching the RoboSpot on, shutters will be closed until you activate the FollowSpot Controller (by pressing the button ACTIVE). After its activating, fixtures can receive DMX values for shutters from control desk.

On - After switching the RoboSpot on, shutters can be controlled from the desk without activating the FollowSpot Controller.

Ctrl On When PWR On - if the function is on, the FollowSpot Controller are automatically activated after connecting power to the FollowSpot Controller.

Password Settings - the menu item allows you to change the password or switch it on/off at entry the FollowSpot Controller menu. The password applies to the FollowSpot Controller as well as to the RoboSpot 15.6" screen.

Change password - use this option to change password. Default (factory) password is 5242.

Protect with Password - If this function is on, the password is required at entry the FollowSpot Controller menu.

Note: both menu items stated above require inserting of password to enter them even the password is set off ! You have to remember the last set password!

In case you have forgotten your password, use the master password 4678.

Recalibrate Touchscreen - the item starts calibration of the touchscreen. Follow instructions on the screen. The touchscreen calibration can also be triggered by pressing Enter + Escape buttons together for 3 seconds and then releasing.

Default Settings - The menu item allows you to set the FollowSpot Controller and LCD monitor to the default (factory) values separately.

Note: The FollowSpot Controller menu will be set to default values except Ethernet Settings. The password will not be set to a default password (set password will remain without change) but the option Protect with Password will be set to On.

Via LCD monitor will be set to default values also Raspberry device in the Robospot base and its settings: MDC setup, dimmer mapping, shows, position and colour buttons, cursors....

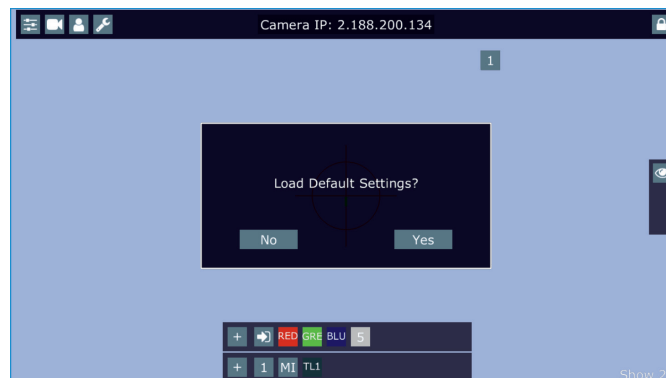

7. Software update

RoboSpot software update is done via a network connection between a computer running a ROBE RDM Uploader software through the CAMERA input (RJ45) of the RoboSpot base station. It is important to note, that computer IPv4 address has to be set to 10.x.x.x network (for example 10.0.1.10) with netmask 255.0.0.0 . During the update, the FollowSpot Controller has to be attached to the RoboSpot.

Do note, that to enable all new features, you must update the RoboSpot base station and also all BMFL fixtures controlled by the RoboSpot system.

To update software in the Robospot.

1. Connect a computer running ROBE RDM Uploader to the internet and update software libraries (Libraries → Update)
2. Connect the computer and the RoboSpot base station via Ethernet cable. Use the RJ45 socket marked Camera IN/Update on the RoboSpot base station for this connection.
3. Set computer to address 10.x.x.x/255.0.0.0 (do note the 10.x.x.x). Do not change any IP settings on the RoboSpot.
4. Use the ROBE Uploader → Devices → Discovery and Devices → Update. This will update RoboSpot together with the attached FollowSpot Controller panel. The message "Flashing Mode. Please do not touch any buttons!" will appear on the RoboSpot screen during updating process.

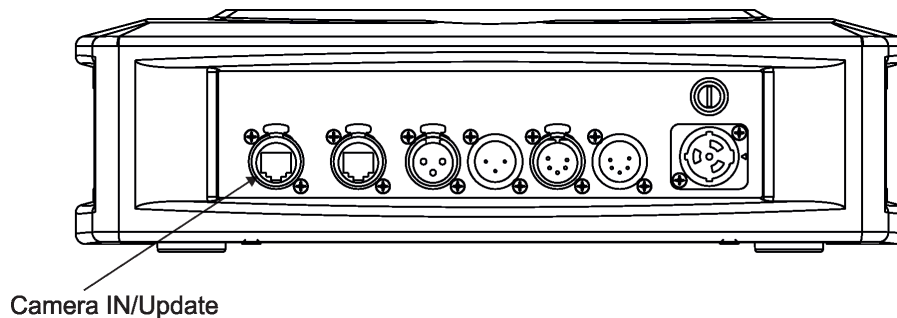

8. Error and information messages

RoboSpot screen

Error message is signalled by the warning icon in the right top corner of the RoboSpot screen:

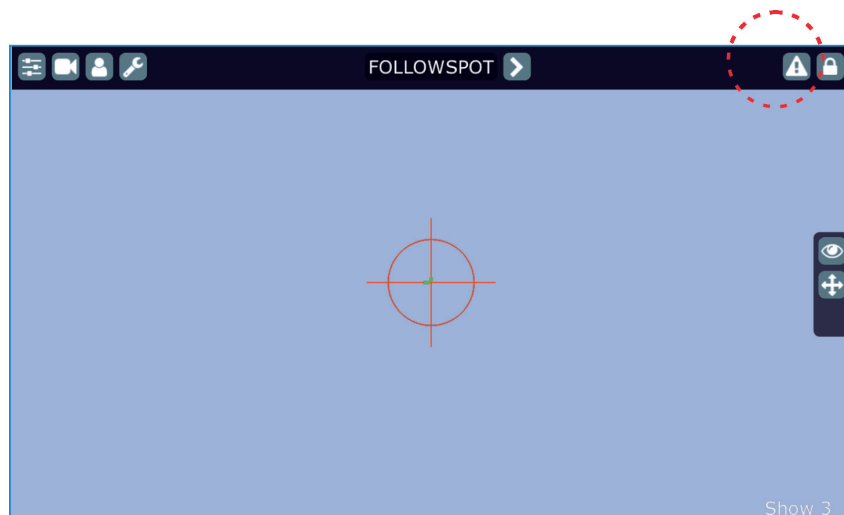

Touch the warning icon to display a message. Touch the screen to hide the message.

List of error and information messages:

Display Communication Error.

This message informs you the FollowSpot Controller is not installed in the FollowSpot Controller base or the connection between the FollowSpot Controller and a computer in the RoboSpot base is faulty.

No actual software in RoboSpot Controller.

Please update to the latest software.

This message informs you the software update of the RoboSpot system should be done.

 This picture on the RoboSpot screen informs you that the Raspberry engine inside the RoboSpot does not have a sufficient voltage on its input (e.g. you have connected a USB flash drive with high power consumption).

FollowSpot Controller

Error message is signalled by the **red line on the display of the FollowSpot Controller** and the menu item "Error Messages" will appear as first in the control menu of the FollowSpot Controller.

Example:

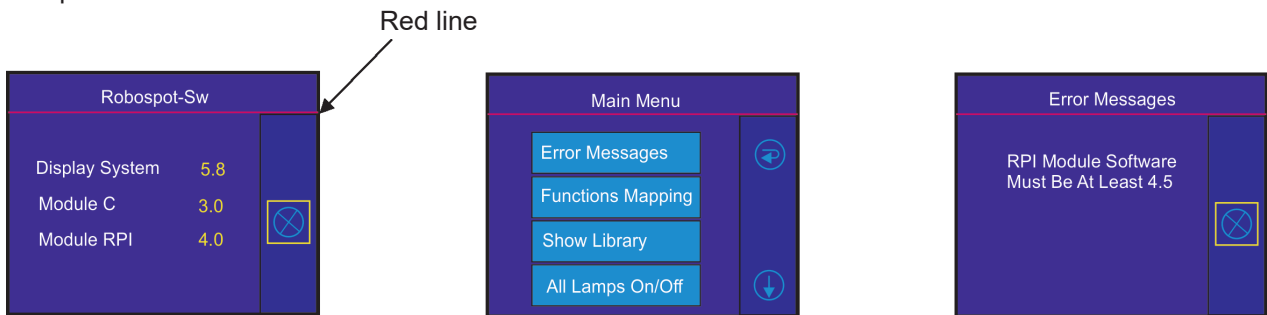

RPI Module Software Must Be At Least 4.5

This message informs you that the Robospot needs software update.

Device Out Of Universe

Incorrect DMX address on some fixture. Range of its channels is out of the used Universe. The Universe is a single DMX 512 frame of 512 channels.

E.g. fixture has DMX address 510.

9. Technical specifications

Input voltage:	100-240V AC
Power consumption:	15W (power factor=0.43, I=0.12A at 230V)
Fuse:	T 2 A
LCD Monitor:	ASUS VT168 H (panel size:15.6" , max. resolution:1366 x 768)
Setting & Control:	graphic touch screen
Protocols:	RDM, ArtNet, sACN,gMA I, gMA II, support of PosiStageNet protocol on both outputs (Camera, Ethernet)
Control elements:	20 buttons, 4 jog-wheels and 2 faders
Connection:	DMX In/Out: Locking 3-pin and 5-pin XLR Ethernet: RJ 45 Camera: RJ 45 AC power: Neutrik powerCON TRUE1 Monitor: HDMI USB lamp: 2x USB socket +5V/50mA 1 x USB
Pan range:	+/- 80°
Tilt range:	+/- 40°
Fastening:	via adaptor on tripod
Maximum ambient operating temperature :	40° C
Minimum ambient operating temperature:	0°C
Dimensions (mm)	

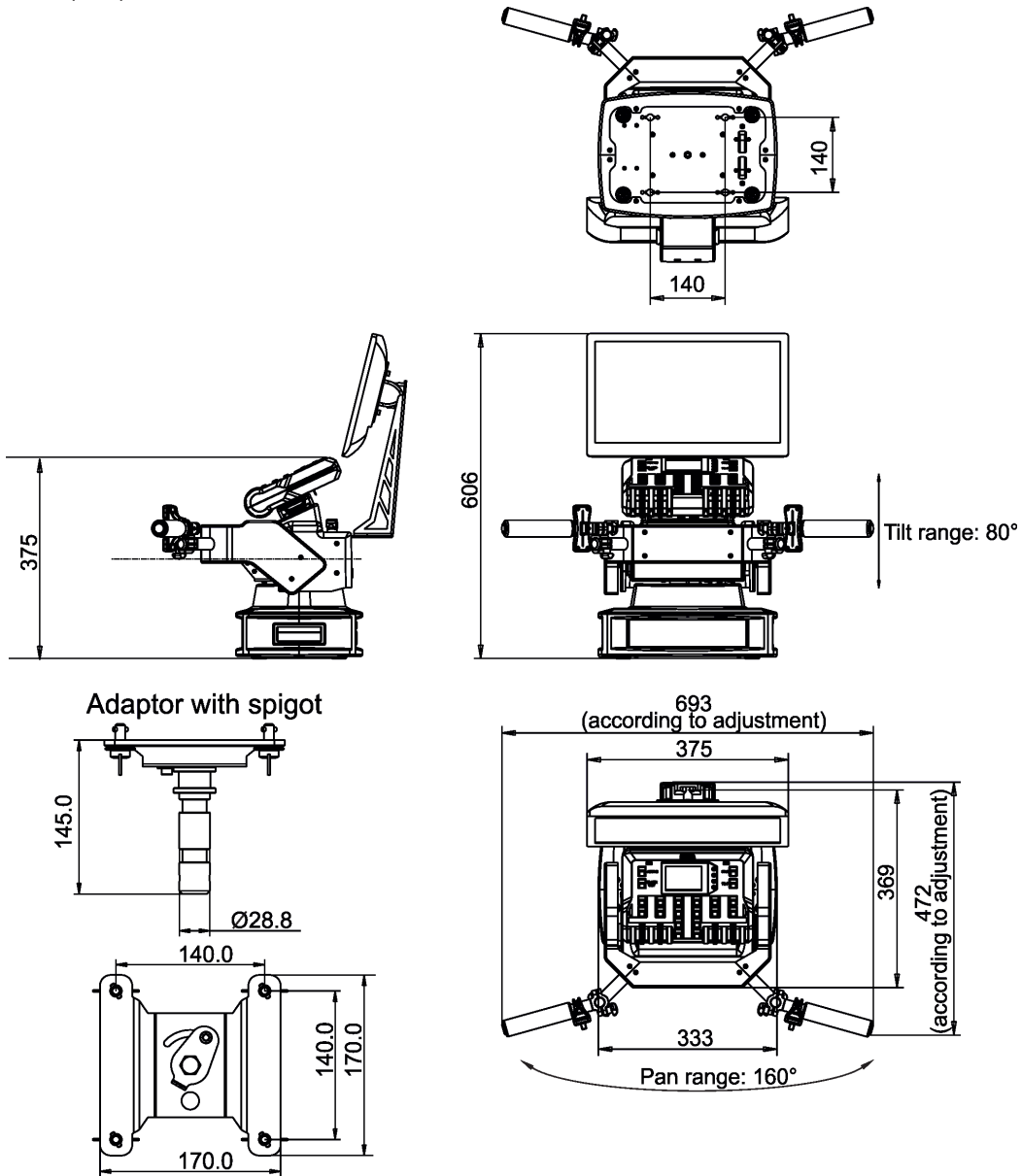

Dimensions with monitor shield and note holder (mm)

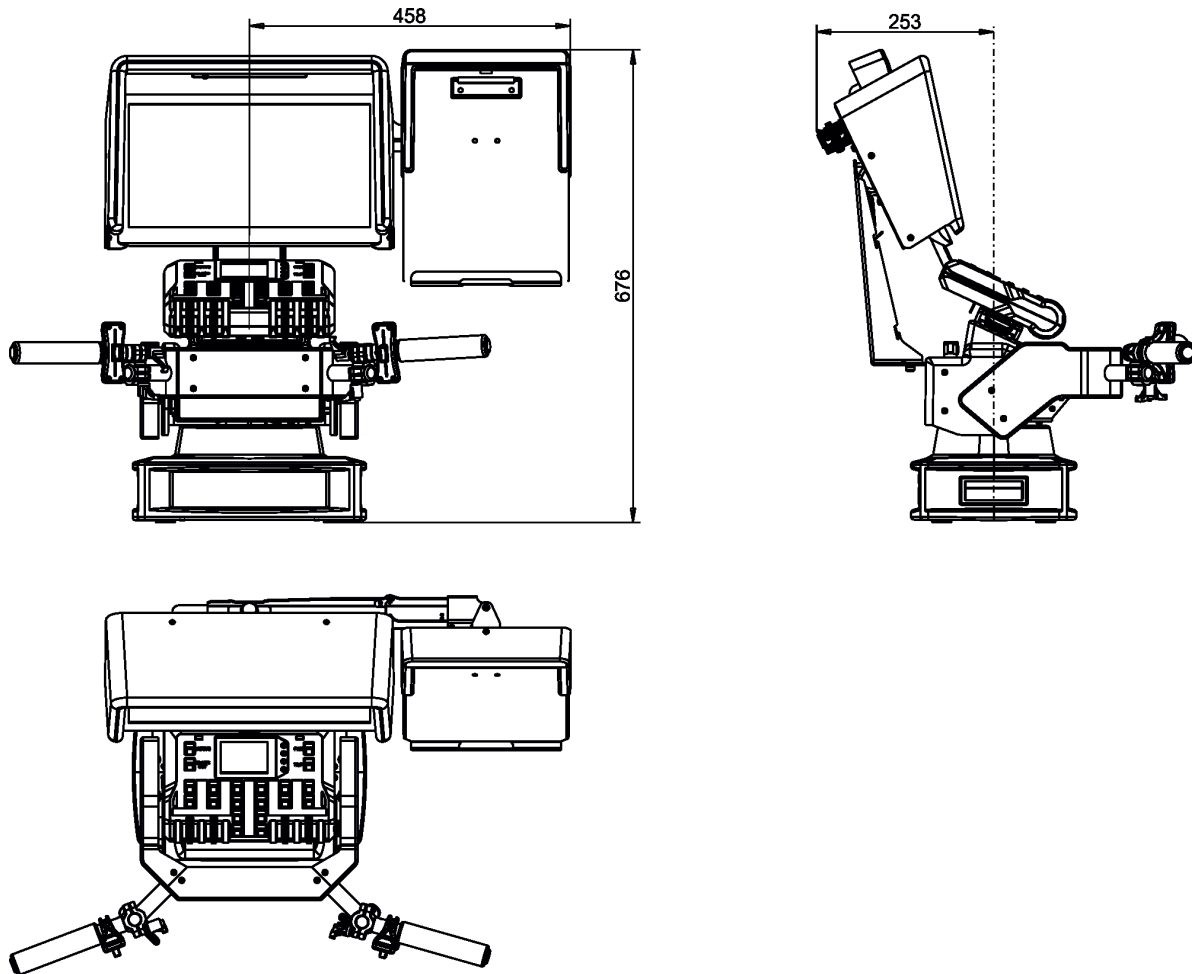

Weight: 16.5 kg (RoboSpot), 1.9 kg (Monitor Shield + Note Holder), 1.7kg (Adaptor), 8.7 kg (Tripod)

Supported fixtures: BMFL FollowSpot / FollowSpot LT, BMFL Spot, BMFL Blade, BMFL WashBeam, BMFL WashBeam EV, Esprite, Esprite FS, Esprite Fresnel/PC Forte, Forte FS, iForte iForte FS, Forte Fresnel/PC, iForte LTX FS, iForte LTX WB, T1 Profile, T1 Profile FS, T1 Wash, T2 Profile, T2 Profile FS, T2 Wash, DL7S Profile, DL4S Profile, iSpider, TX1 PosiProfile, iBeam 350, iPointe65, iEsprite, iEsprite FS, iPointe, MegaPointe, Pointe, Painte, Spote, Cuete, ProMotion, Viva CMY, SilverScan, Tarrantula, Spider, LEDBeam 150, LEDBeam 350, Footsie 1, Footsie 2, MMX WashBeam, MMX Blade

Included items

- 1 x RoboSpot
- 1 x Adaptor (including spigot) (P/N 99015404)
- 1 x Tripod for RoboSpot/FollowSpot/LightMaster (P/N 10980350)
- 1 x Power cable
- 1 x User manual

Optional accessory

- Monitor Shield and Note Holder for RoboSpot BS (P/N 10980409)*
- Monitor Shield and Note Holder II for RoboSpot BS (P/N 10980678)
- Water-resistant RoboSpot system protection cover (P/N 23049107)

* Suitable for 15.6" monitor Asus VT168H only

10. Maintenance and cleaning

DANGER !
**Disconnect from the mains before starting any
maintenance work**

A soft lint-free cloth moistened with cleaning fluid is recommended, under no circumstances should solvents be used! For cleaning of the LCD monitor use a fluid intended for this purpose.

Never use solvents for cleaning the device

More complicated maintenance and service operations are only to be carried out by authorized distributors.

10.1 Replacing the fuse

Replace the fuse by a fuse of the same type and rating only.

Before replacing the fuse, unplug mains lead!

- 1) Remove the fuse holder on the rear panel of the base with a fitting screwdriver from the housing (anti-clockwise).
- 2) Remove the old fuse from the fuse holder.
- 3) Install the new fuse in the fuse holder (only the same type and rating).
- 4) Replace the fuse holder in the housing and fix it.

10.2 Replacing the encoder battery

The pan and tilt encoders can use one of the following types of batteries - either soldered or inserted into a battery holder.



Battery ER14250 soldered (P/N 13053566)



Battery ER14250 (P/N 13053542)

It is not possible to determine the type of battery from serial number of the RoboSpot. Battery replacement might be needed after some 4-6 years of RoboSpot usage.

The need for battery replacement may be determined by the need to frequently repeat calibration of the RoboSpot handles or by an erroneous behavior of the pan/tilt encoders.

Procedure of battery replacement is described in the Technical Bulletin 103 (RoboSpot Encoder battery replacement). Please see the link <https://www.robe.cz/robospot#downloads-58>

Battery is not under warranty!

10.3 Disposing of the product

To preserve the environment please dispose or recycle this product at the end of its life according to the local regulations and codes.

Specifications are subject to change without notice.

March 18, 2024

Copyright © 2017-2024 Robe Lighting - All rights reserved

Made in CZECH REPUBLIC by ROBE LIGHTING s.r.o. Palackeho 416/20 CZ 75701 Valasske Mezirici

